



COMBI BLINDS

콤비 블라인드

COMBI BLINDS | 콤비 블라인드

Min. SQM : 2.0m² / Min. Height : 150cm

Round Corner Rail (Slim)
라운드코너 레일 **S**



Round Corner Rail (Regular)
라운드코너 레일 **R**



Round Corner Rail (Large)
라운드코너 레일 **L**



[Round Corner Rail **S** & Bottom Rail]

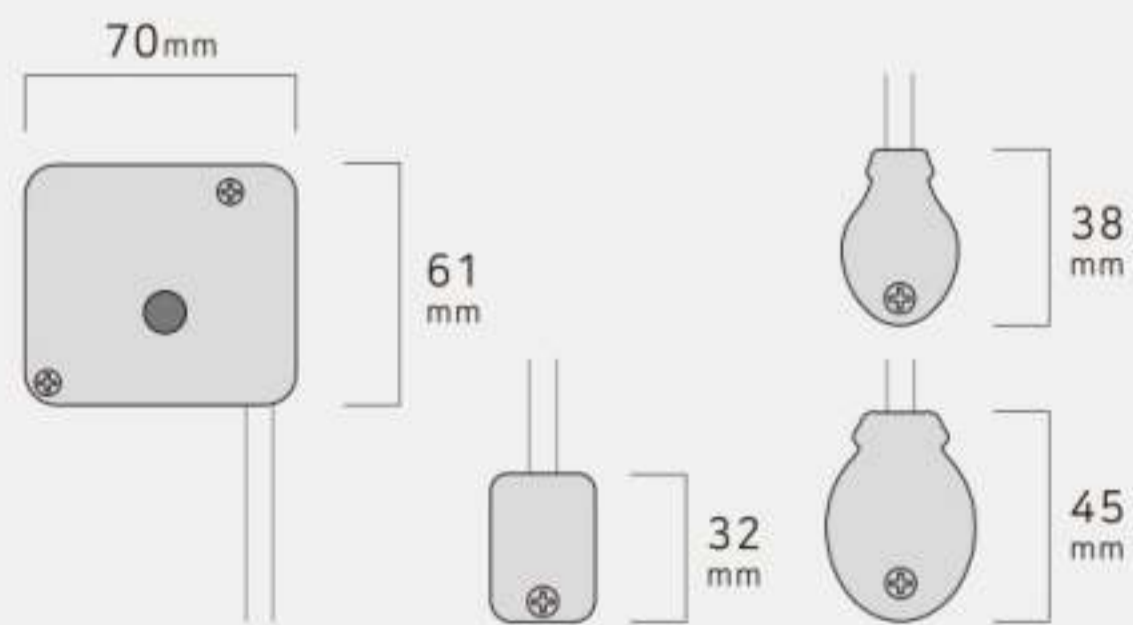

[Round Corner Rail **R**]

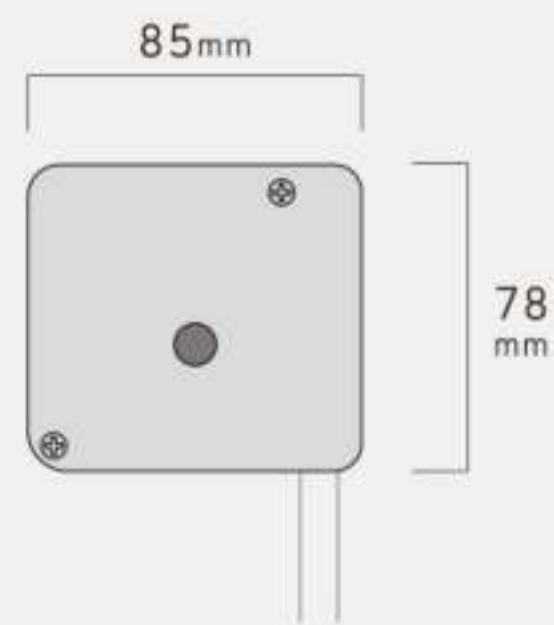

[Round Corner Rail **L**]

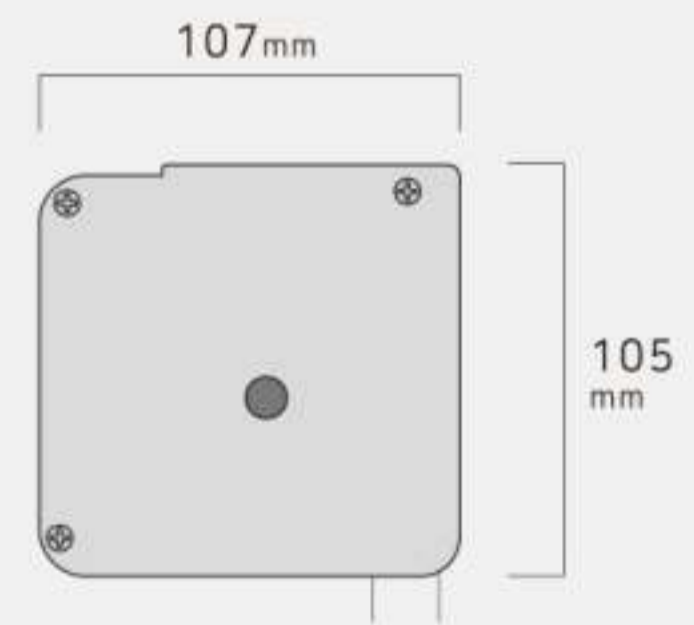

Rail Color



(인쇄 품질에 따라 실물과 색상 차이가 날 수 있습니다)



CODE NO. W250B40647

콤비 | 카밀라 암막 (방염)

Camilla B/O (F/R)



CMA 5101 White 화이트

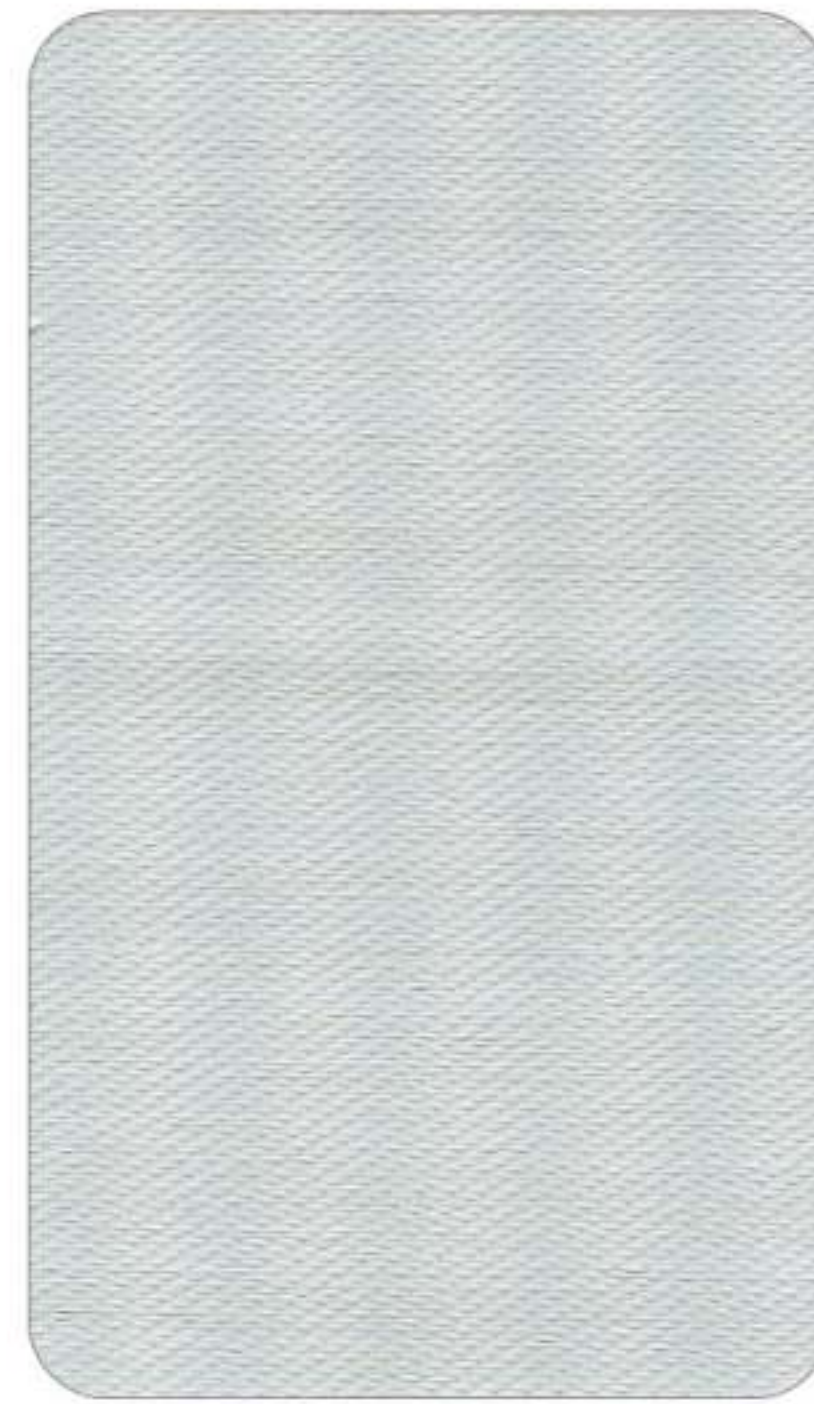

CMA 5102 Ivory 아이보리



CMA 5103 Beige 베이지

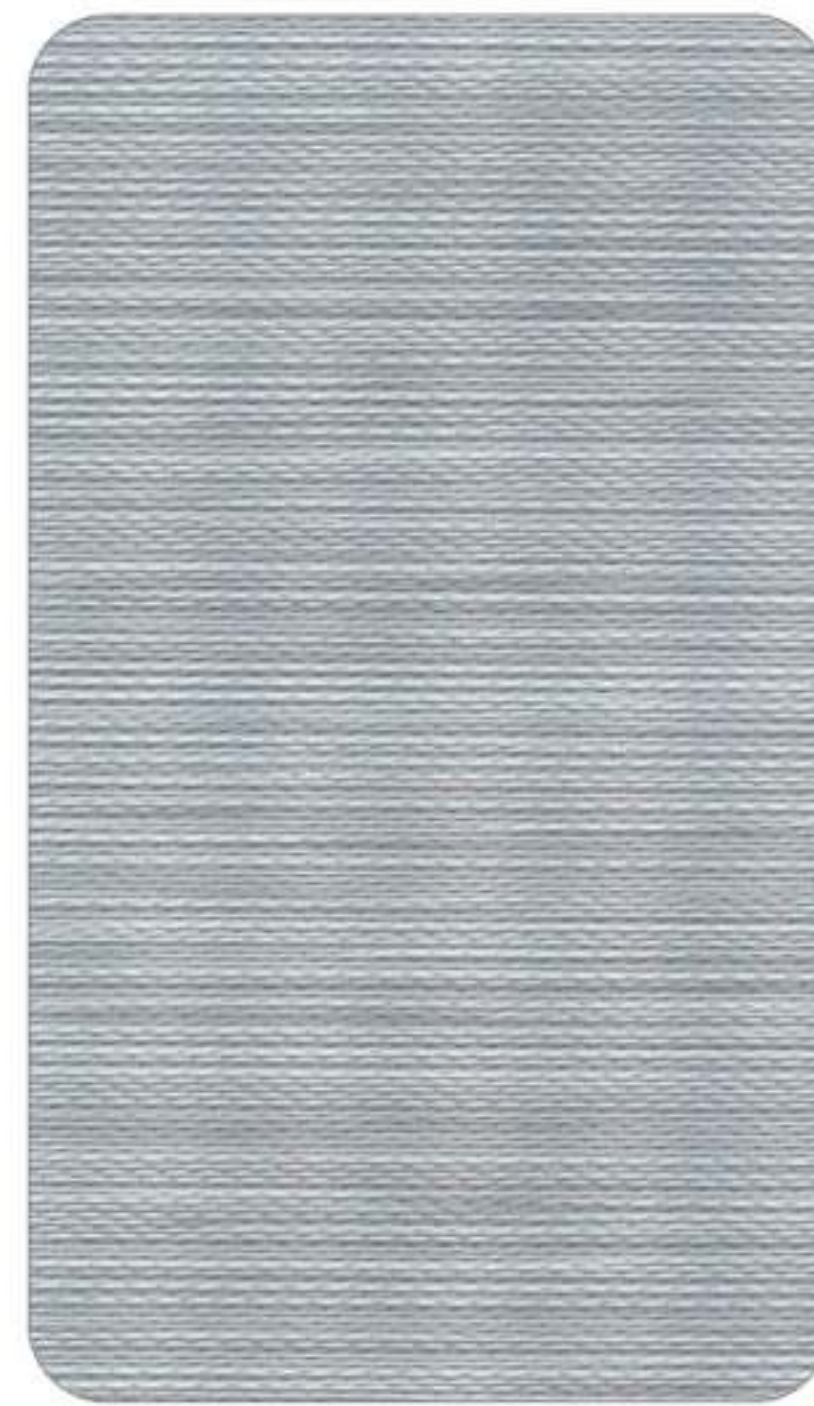

CMA 5104 Grey 그레이



CMA 5105 Dark Brown 다크 브라운

COMBI BLINDS | 카밀라 암막 (방염)·Camilla B/O (F/R)

COMPOSITION	Polyester 100%	WIDTH	280cm
WEIGHT	153g / m ² ± 5 %	THICKNESS	0.45mm ± 5 %
REPEAT	Solid 100mm / Sheer 70mm	FIRE CLASSIFICATION	F/R



- 실내용 / 물세탁 금지 / 구겨짐 주의 / 터치블라인드 제작 가능.
- 생산 LOT에 따라 원단에 미세한 차이가 있을 수 있습니다.
- 앞장 상단의 QR코드를 스캔하시면 설치 이미지를 보실 수 있습니다.

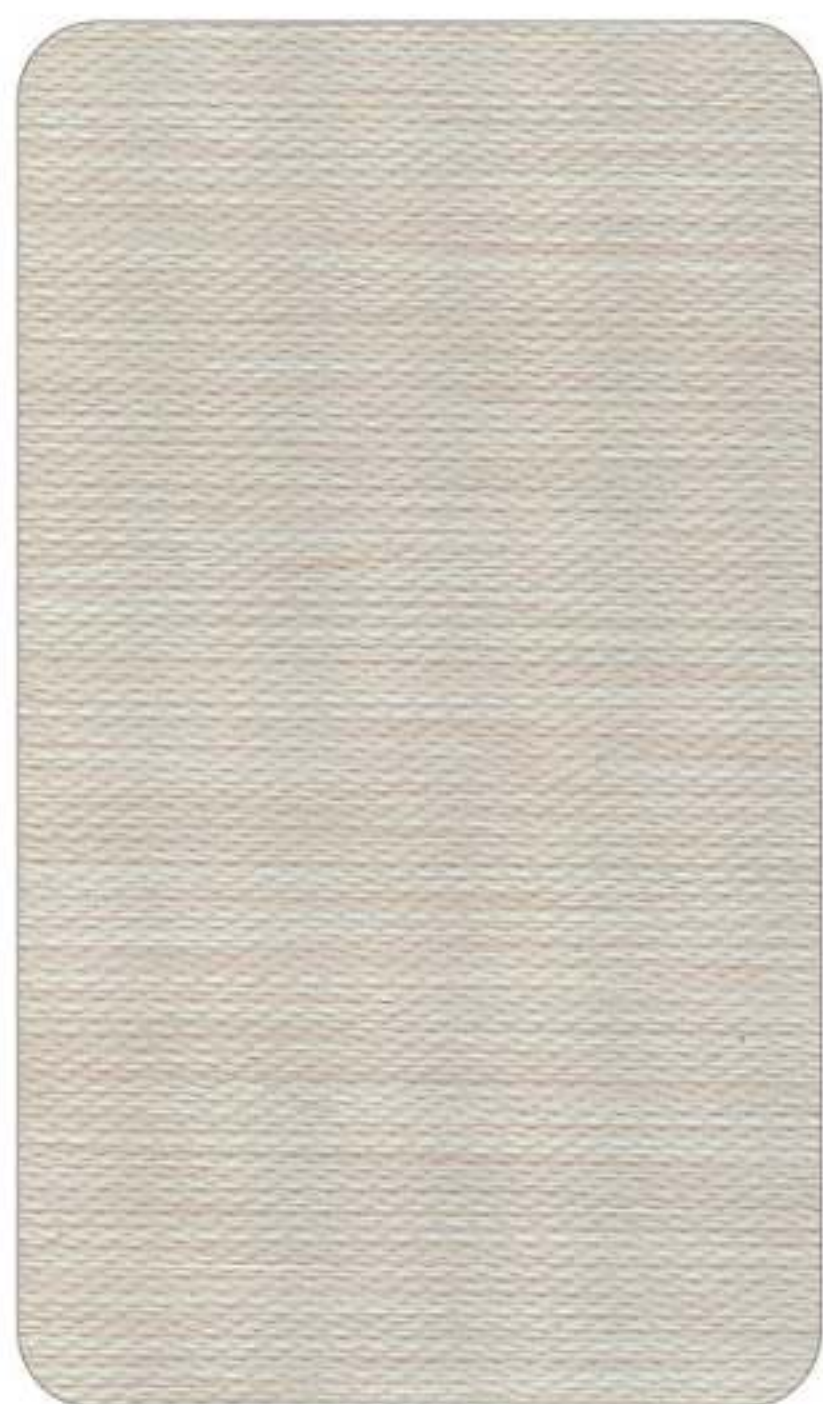

CMA 5103 Beige 베이지

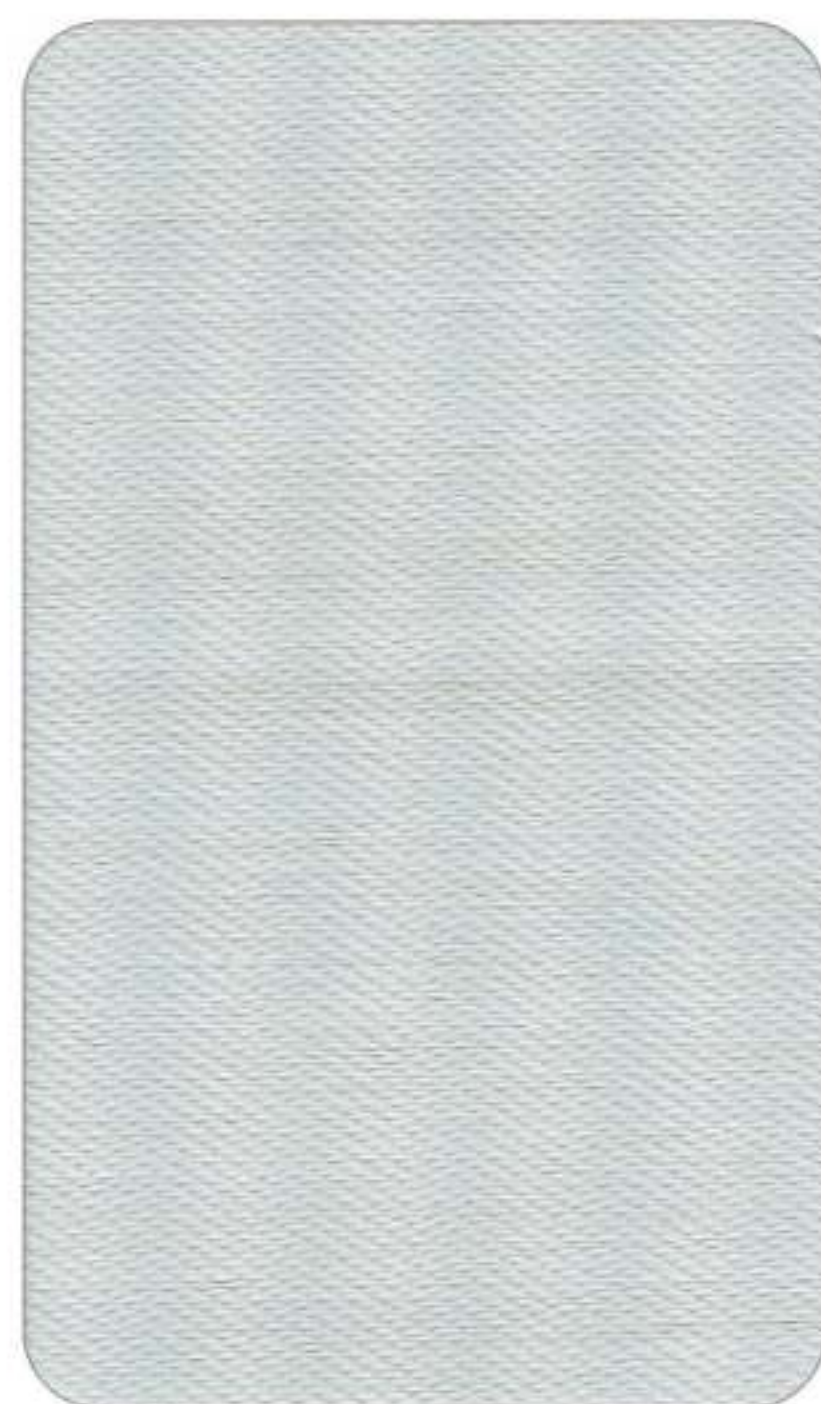

CMA 5102 Ivory 아이보리

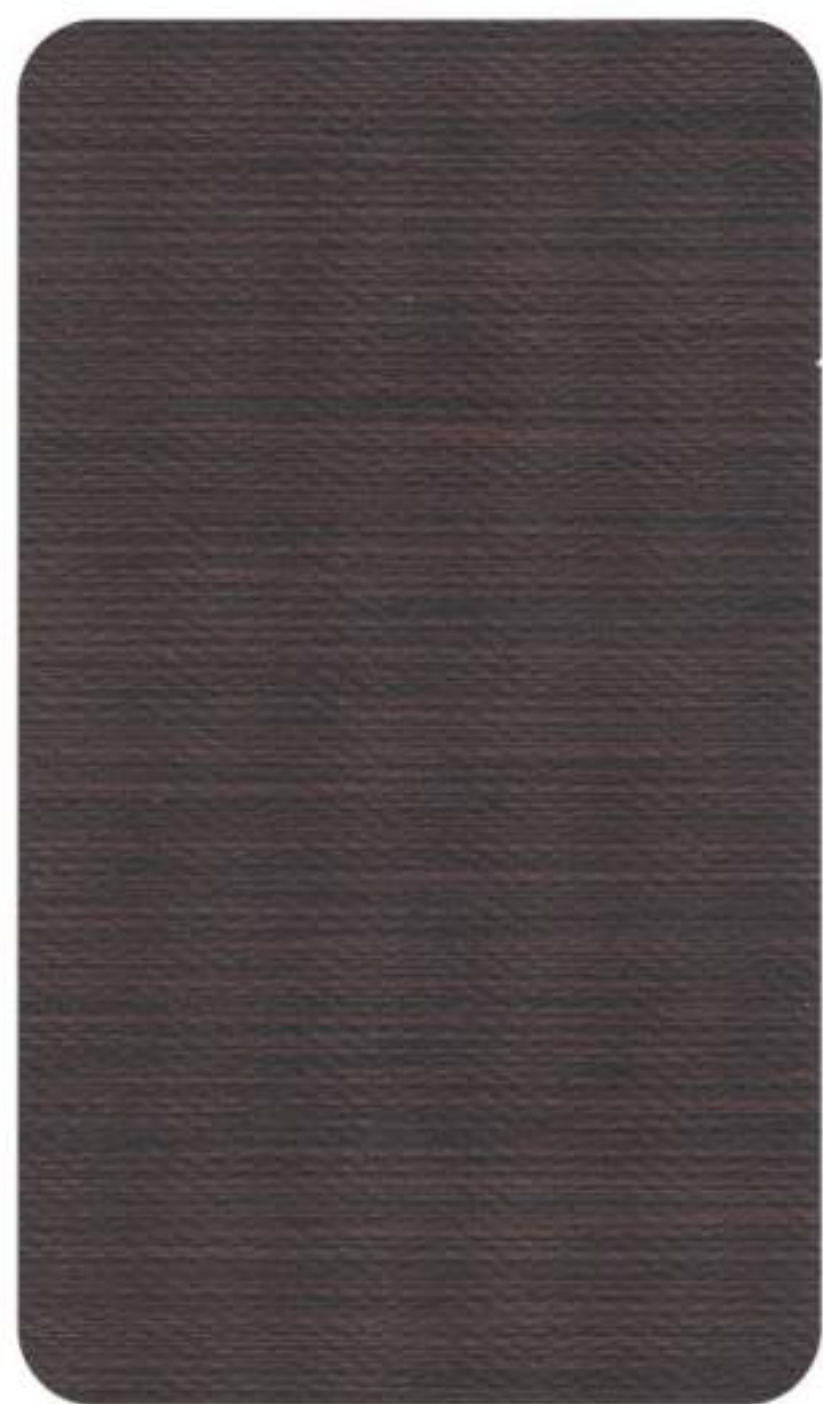

CMA 5105 Dark Brown 다크 브라운

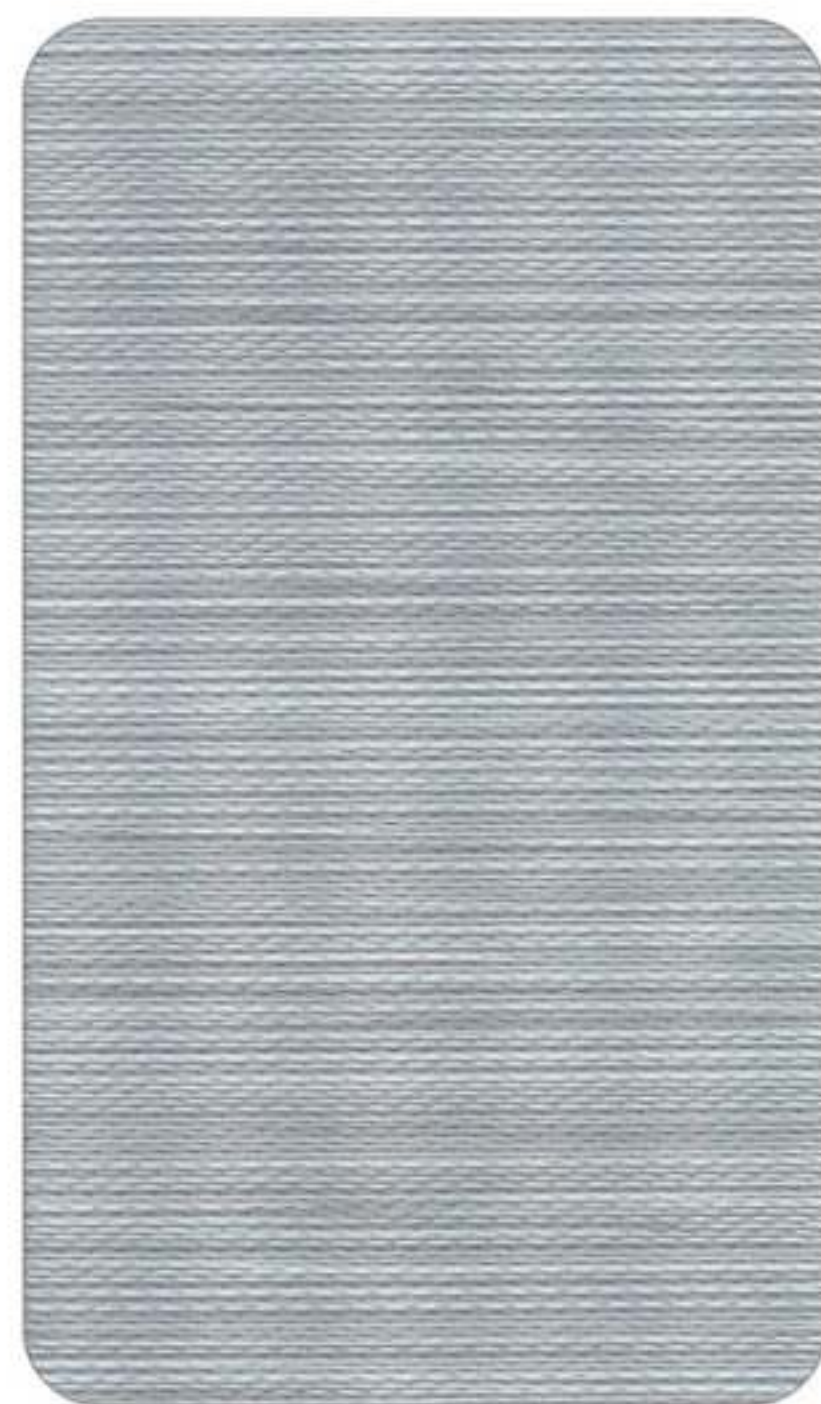

CMA 5104 Grey 그레이



CMA 5101 White 화이트



CODE NO. M210B00775 (F/R: M230B20587)

콤비 | 파르마 암막 (일부방염가능)

Parma B/O



PR 7807 (비방염) Black 블랙
PRF 7887 (방염)



PR 7801 (비방염) Ivory 아이보리
PRF 7881 (방염)



PR 7803 (비방염) Grey 그레이
PRF 7883 (방염)



PR 7805 Brown 브라운

COMBI BLINDS | 파르마 암막 (일부방염가능) · Parma B/O (F/R Available Partly)

COMPOSITION	Polyester 100%	WIDTH	280cm
WEIGHT	188g / m ² ± 5 %	THICKNESS	0.49mm ± 5 %
REPEAT	Solid 100mm / Sheer 60mm	FIRE CLASSIFICATION	None or F/R



- 실내용 / 물세탁 금지 / 구겨짐 주의 / 터치블라인드 제작 가능.
- 생산 LOT에 따라 원단에 미세한 차이가 있을 수 있습니다.
- 앞장 상단의 QR코드를 스캔하시면 설치 이미지를 보실 수 있습니다.



PR 7805 Brown 브라운



PR 7803 (비방염) Grey 그레이
PRF 7883 (방염) 



PR 7801 (비방염) Ivory 아이보리
PRF 7881 (방염) 



PR 7807 (비방염) Black 블랙
PRF 7887 (방염) 



CODE NO. L190A80321

콤비 | 아델라 암막 (방염)

Adela B/O (F/R)

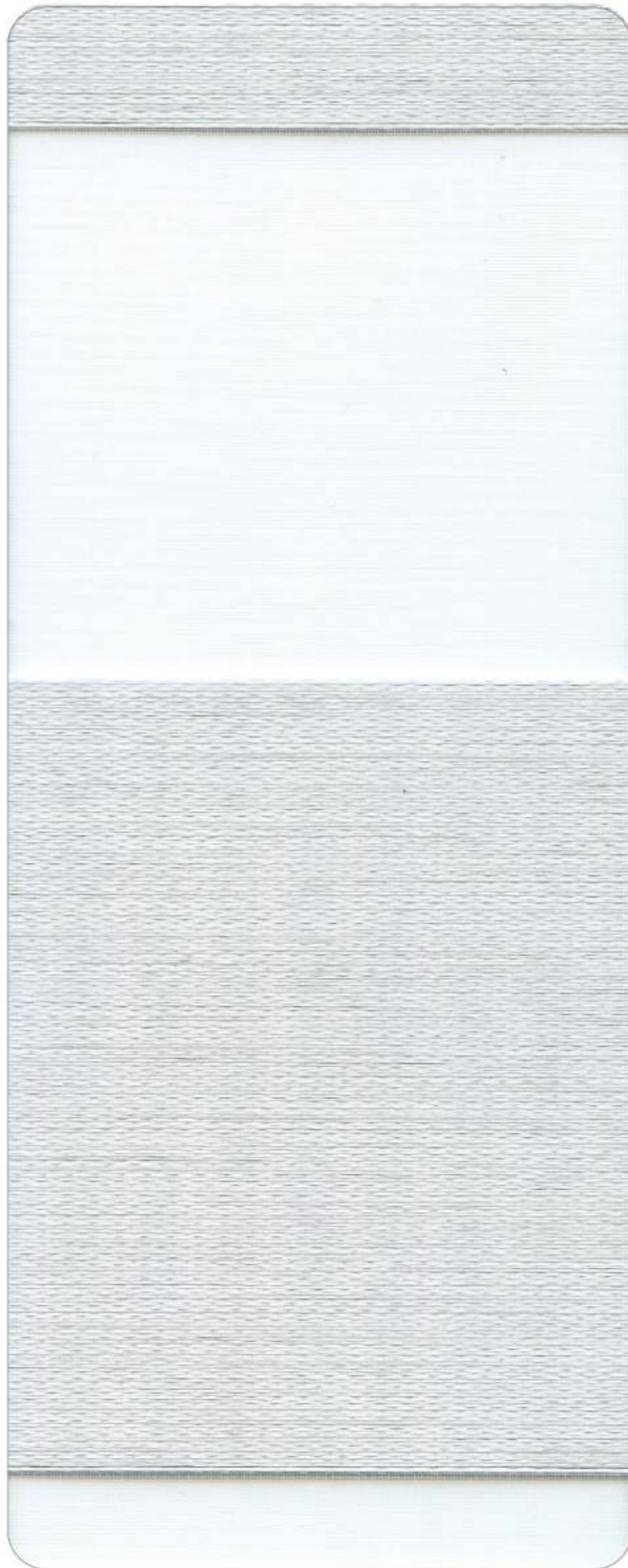

ADL 4271 White 화이트

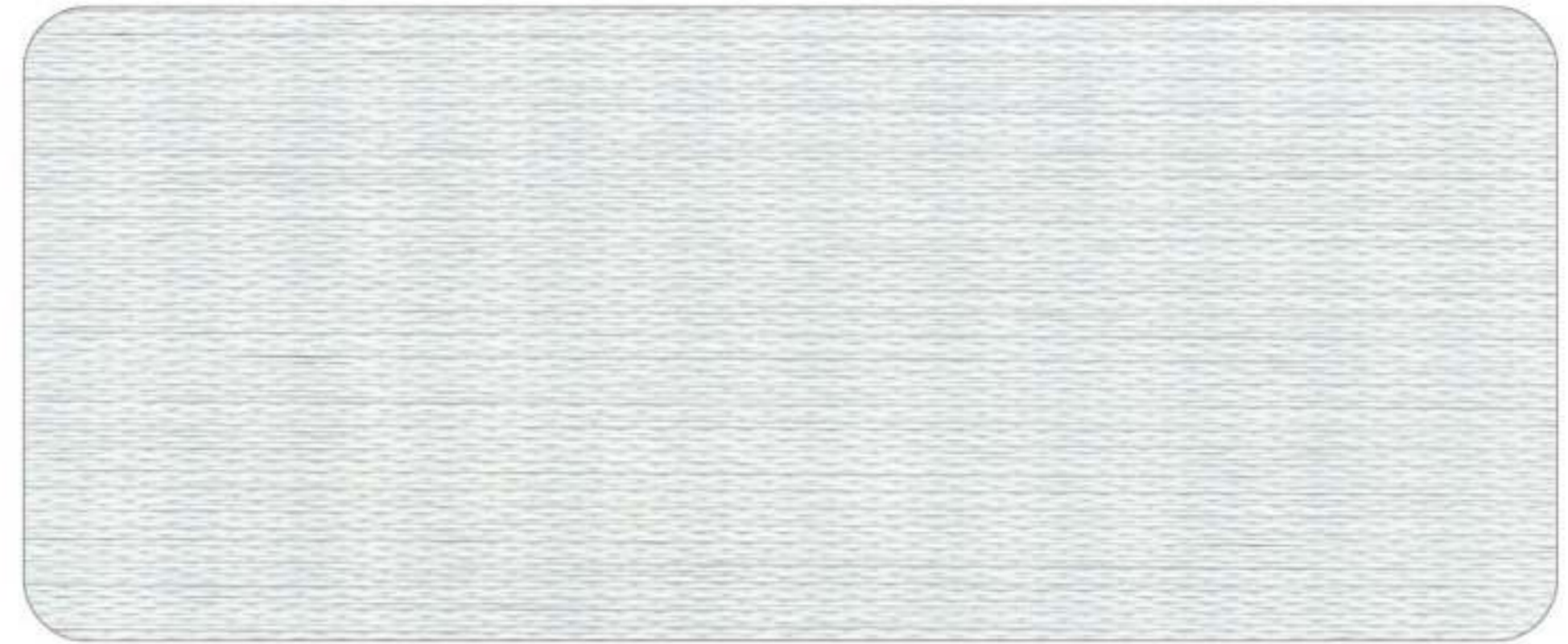

ADL 4272 Ivory 아이보리

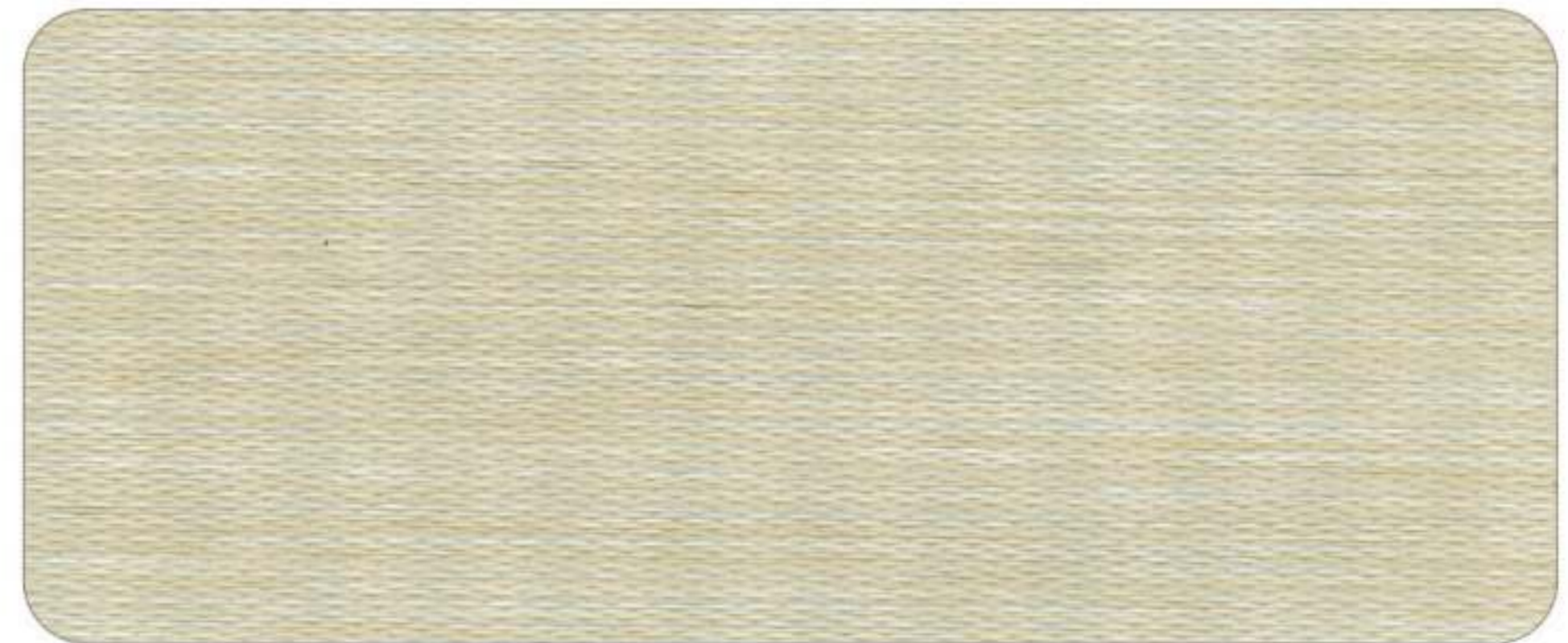

ADL 4273 Beige 베이지

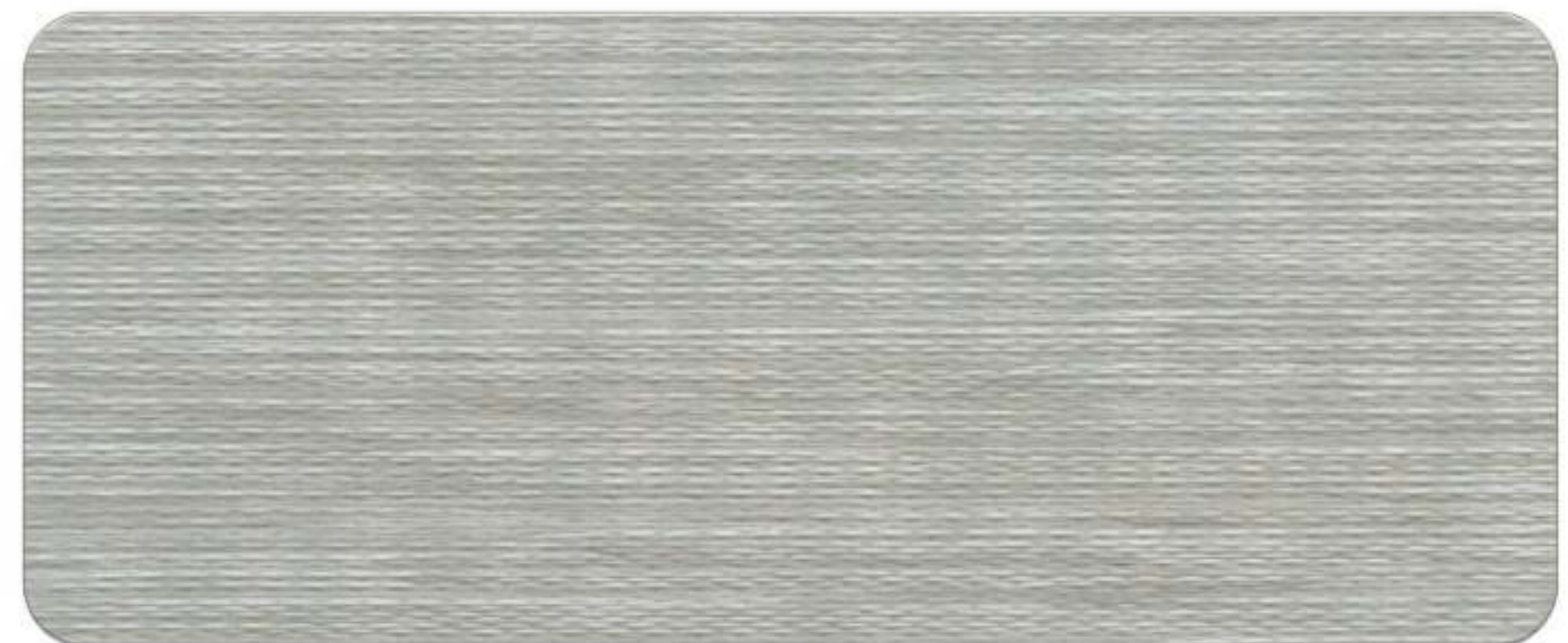

ADL 4274 Grey 그레이

COMBI BLINDS | 아델라 암막 (방염)·Adela B/O (F/R)

COMPOSITION	Polyester 100%	WIDTH	280cm
WEIGHT	185g / m ² ± 5 %	THICKNESS	0.43mm ± 5 %
REPEAT	Solid 100mm / Sheer 70mm	FIRE CLASSIFICATION	F/R



- 실내용 / 물세탁 금지 / 구겨짐 주의 / 터치블라인드 제작 가능.
- 생산 LOT에 따라 원단에 미세한 차이가 있을 수 있습니다.
- 앞장 상단의 QR코드를 스캔하시면 설치 이미지를 보실 수 있습니다.

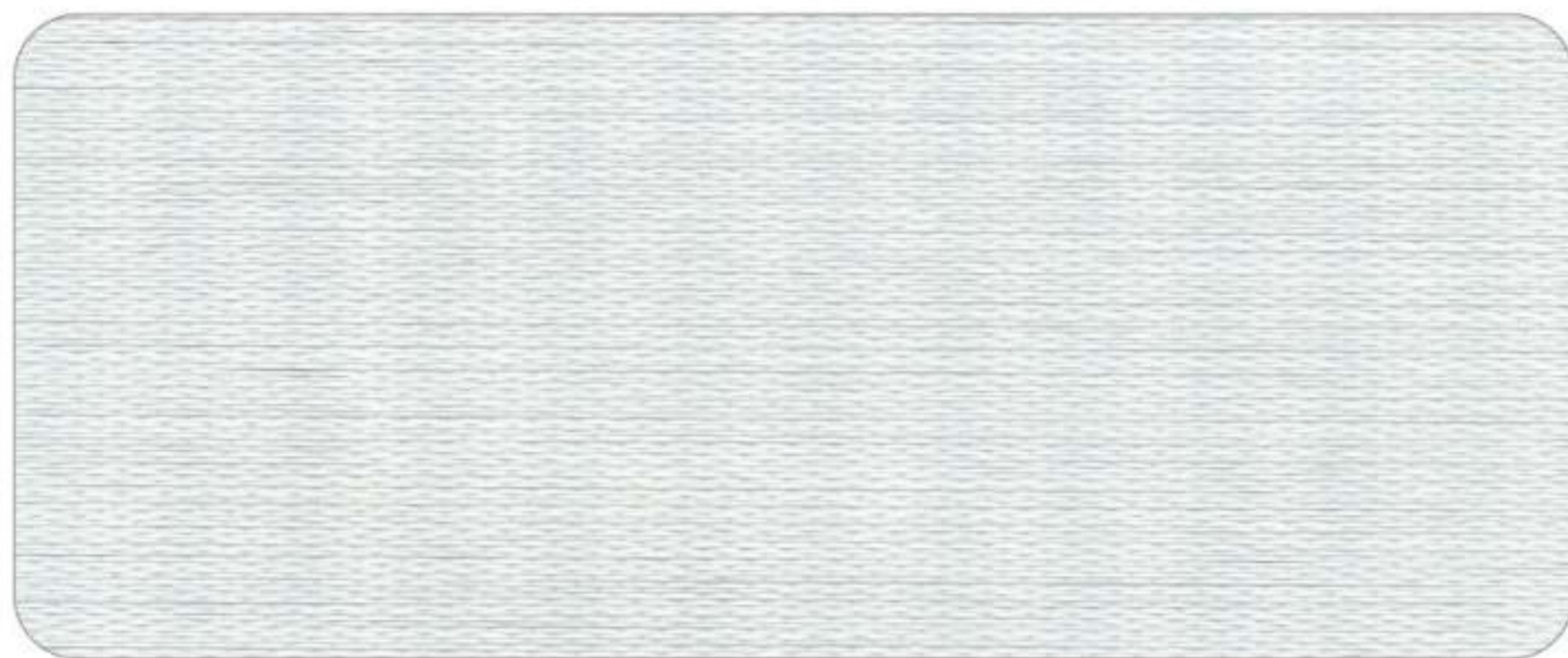

ADL 4272 Ivory 아이보리

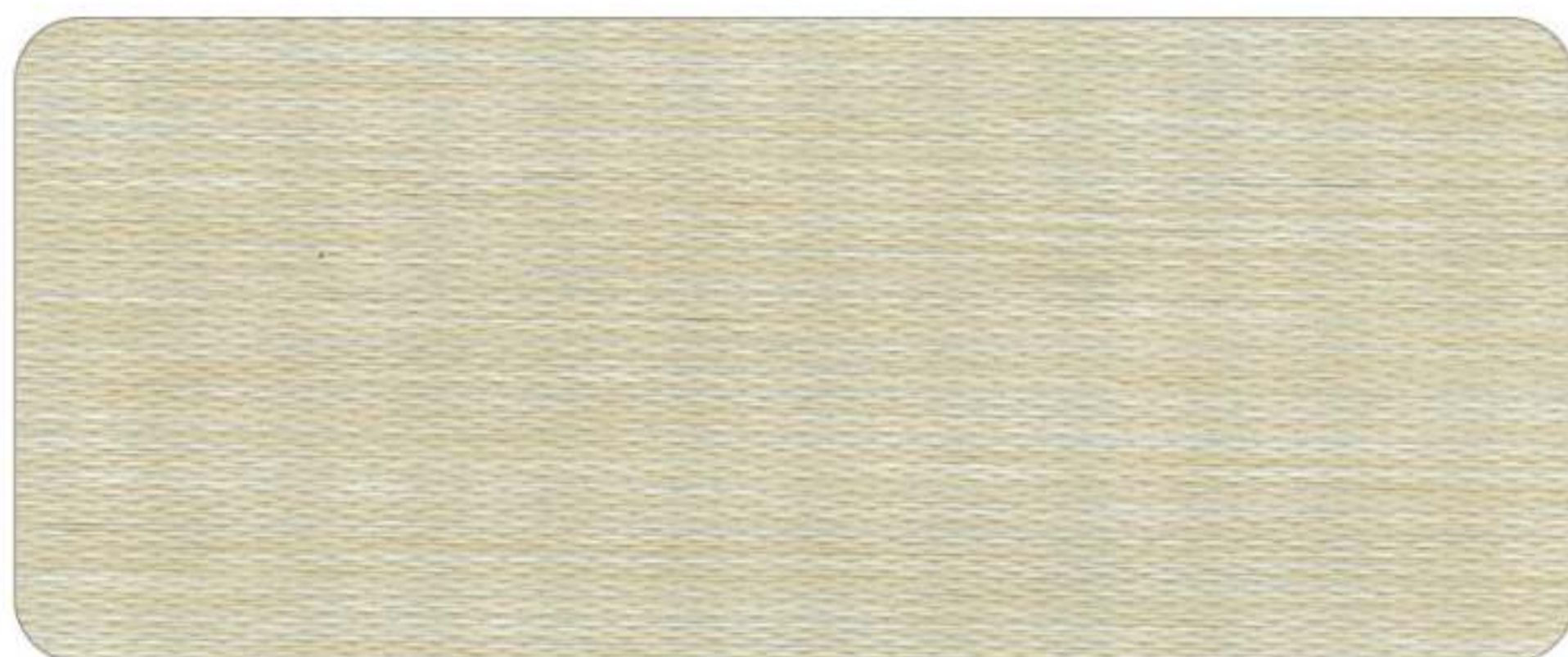

ADL 4273 Beige 베이지

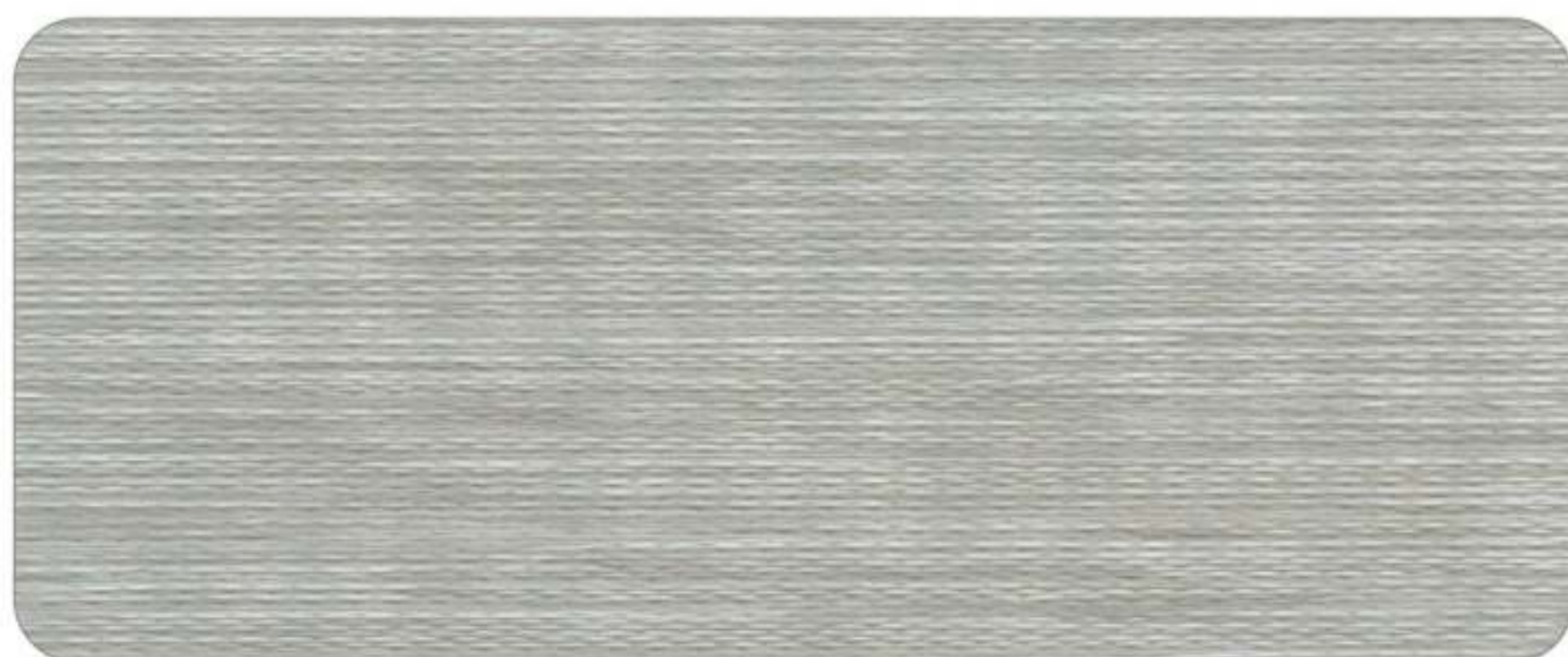

ADL 4274 Grey 그레이

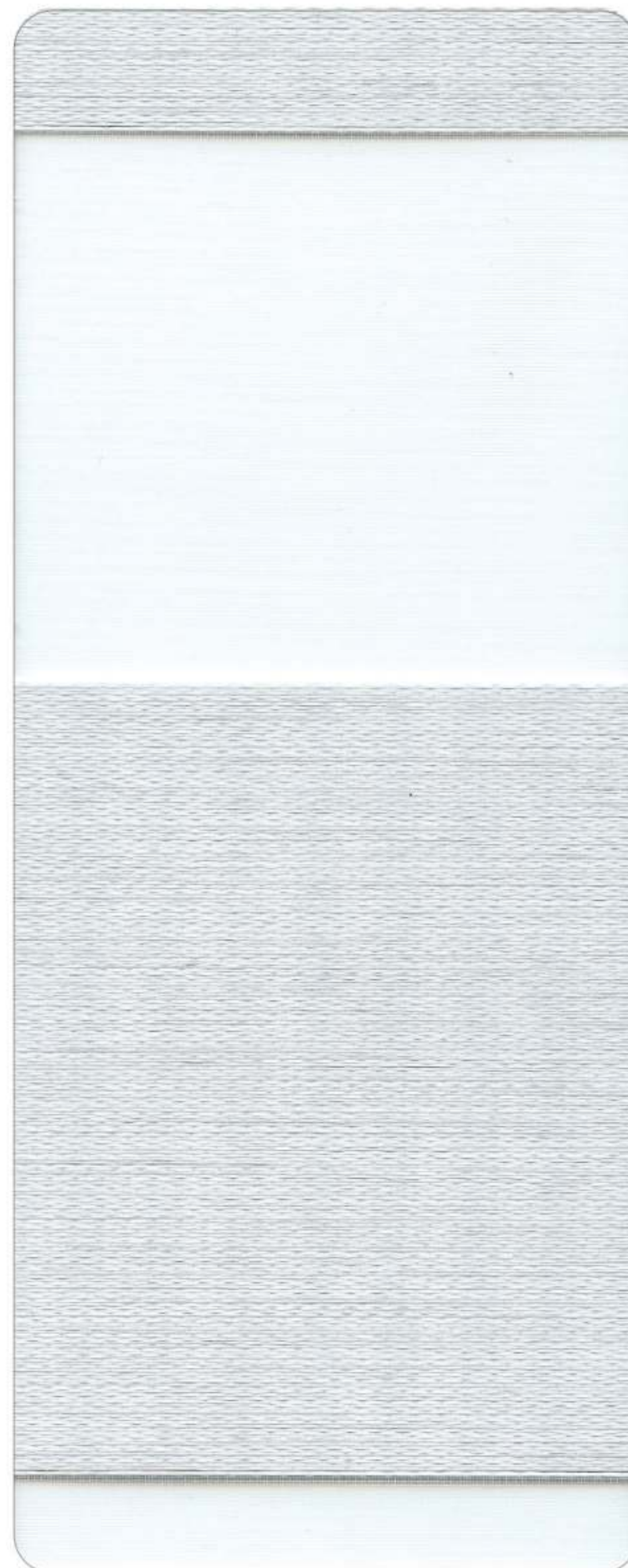

ADL 4271 White 화이트



CODE NO. F220B10334

콤비 | 세잔 (퍼펙트) 암막



Cezanne (Perfect) B/O

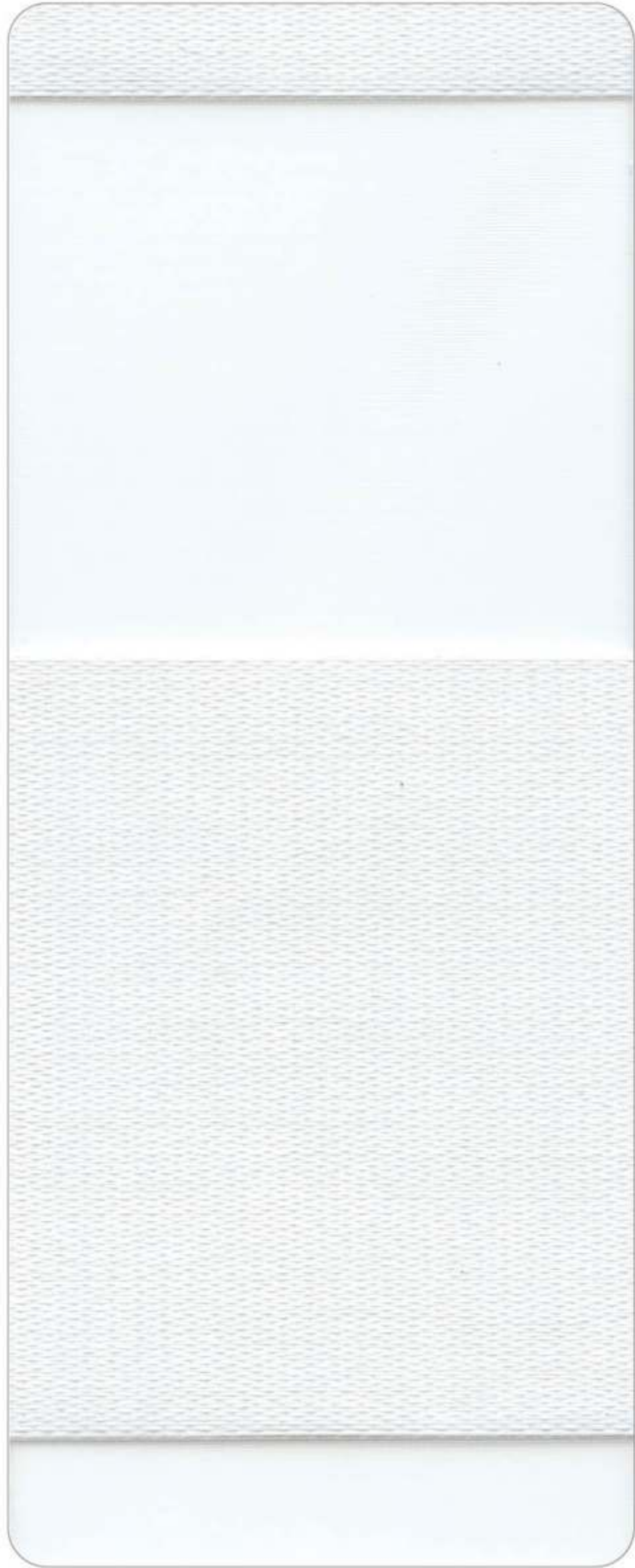

CE 1851 White 화이트



CE 1853 Cream 크림



CE 1854 Beige 베이지

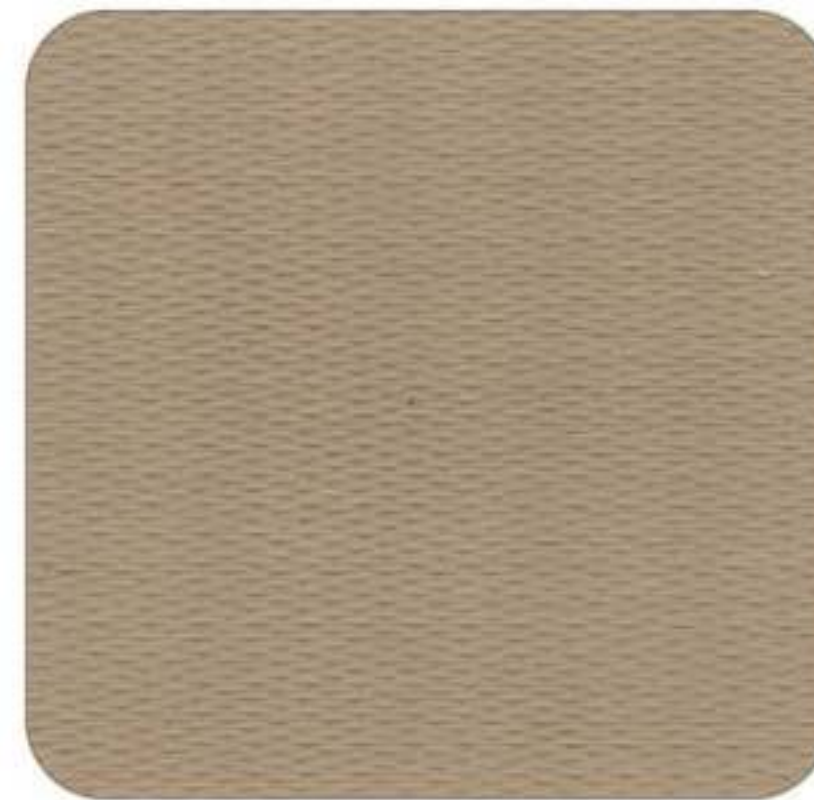

CE 1855 Light Mocha 라이트 모카

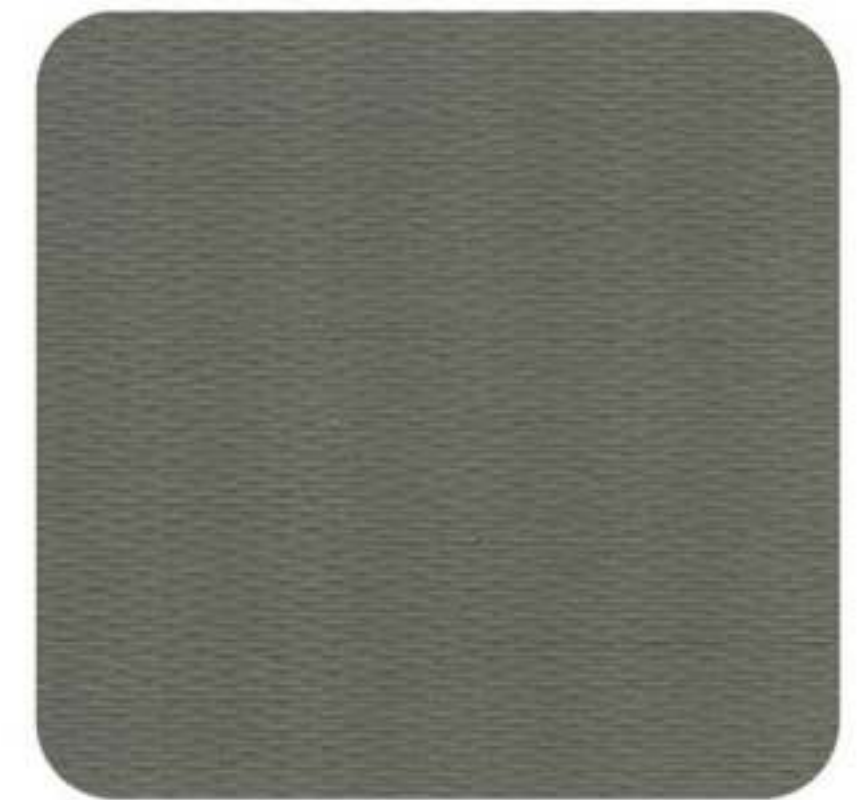

CE 1856 Dark Mocha 다크 모카

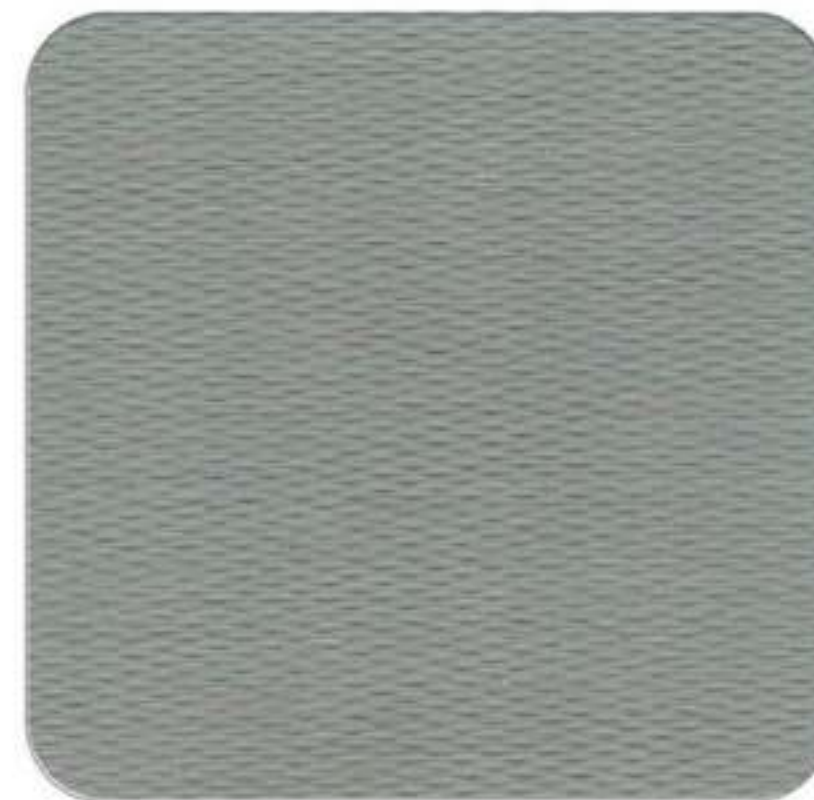

CE 1858 Light Grey 라이트 그레이



CE 1857 Dark Grey 다크 그레이

COMBI BLINDS | 세잔 (퍼펙트) 암막·Cezanne (Perfect) B/O

COMPOSITION	Polyester 100%	WIDTH	280cm
WEIGHT	239g / m ² ± 5 %	THICKNESS	0.61mm ± 5 %
REPEAT	Solid 100mm / Sheer 70mm	FIRE CLASSIFICATION	None



- 실내용 / 물세탁 금지 / 구겨짐 주의 / 터치블라인드 제작 가능.
- 생산 LOT에 따라 원단에 미세한 차이가 있을 수 있습니다.
- 앞장 상단의 QR코드를 스캔하시면 설치 이미지를 보실 수 있습니다.



CE 1854 Beige 베이지



CE 1853 Cream 크림

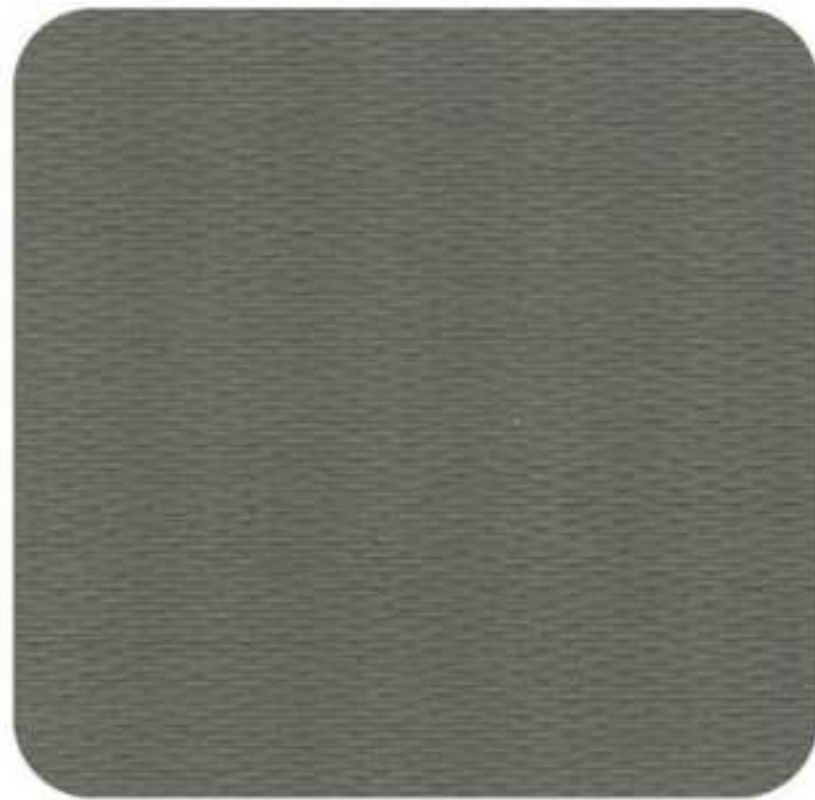

CE 1856 Dark Mocha 다크 모카

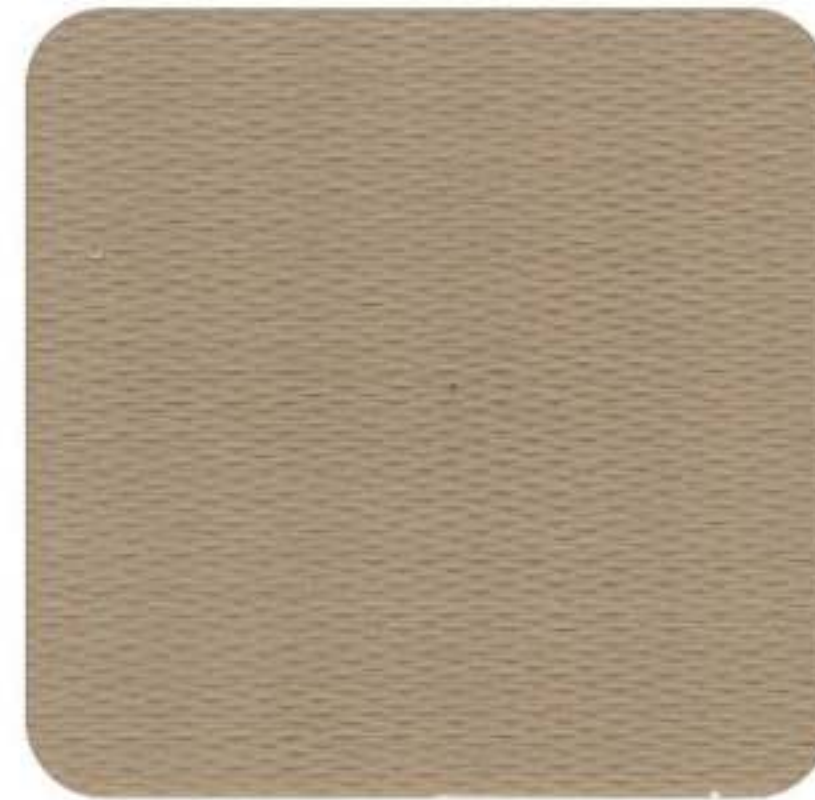

CE 1855 Light Mocha 라이트 모카



CE 1857 Dark Grey 다크 그레이

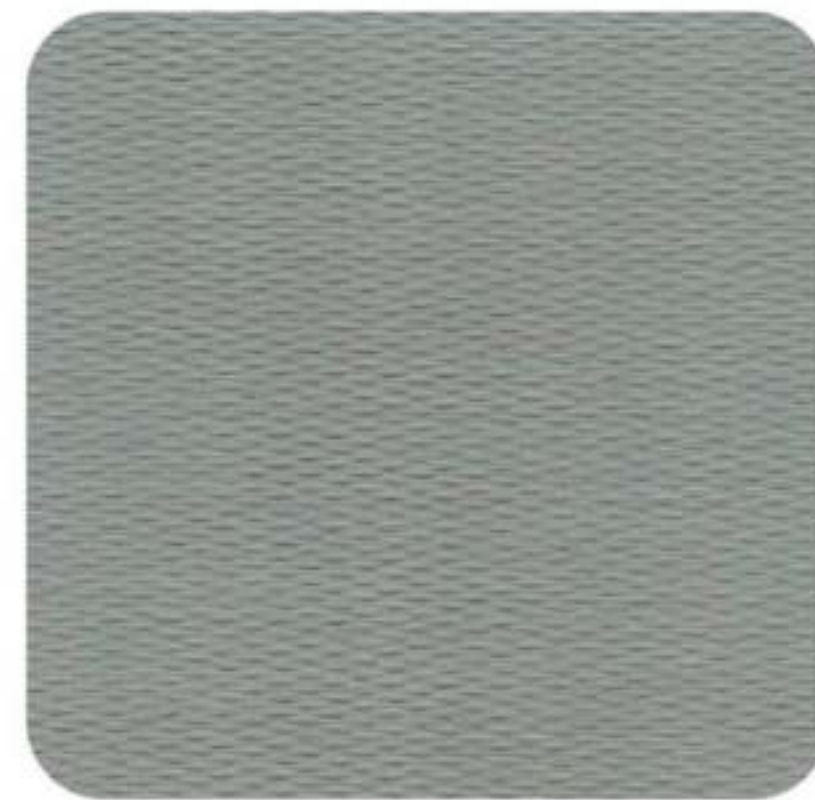

CE 1858 Light Grey 라이트 그레이

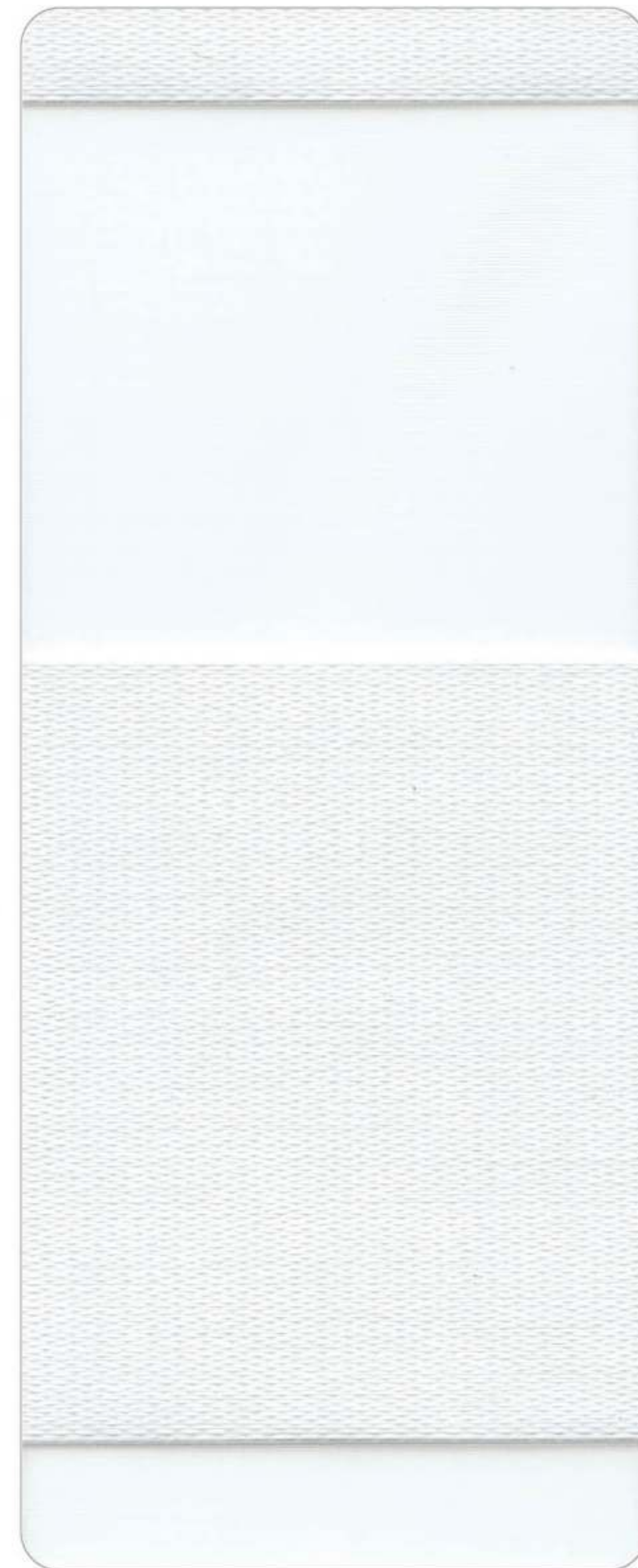

CE 1851 White 화이트



CODE NO. L220B10581

콤비 | 린넨 암막



Linen Blackout



LIB 5951 Linen White 린넨 화이트



LIB 5952 Beige 베이지



LIB 5953 Grey 그레이



LIB 5954 Charcoal 차콜

COMBI BLINDS | 린넨 암막·Linen B/O

COMPOSITION	Polyester 100%	WIDTH	280cm
WEIGHT	184g / m ² ± 5 %	THICKNESS	0.69mm ± 5 %
REPEAT	Solid 100mm / Sheer 70mm	FIRE CLASSIFICATION	None



- 실내용 / 물세탁 금지 / 구겨짐 주의 / 터치블라인드 제작 가능.
- 생산 LOT에 따라 원단에 미세한 차이가 있을 수 있습니다.
- 앞장 상단의 QR코드를 스캔하시면 설치 이미지를 보실 수 있습니다.



LIB 5952 Beige 베이지



LIB 5953 Grey 그레이



LIB 5954 Charcoal 차콜

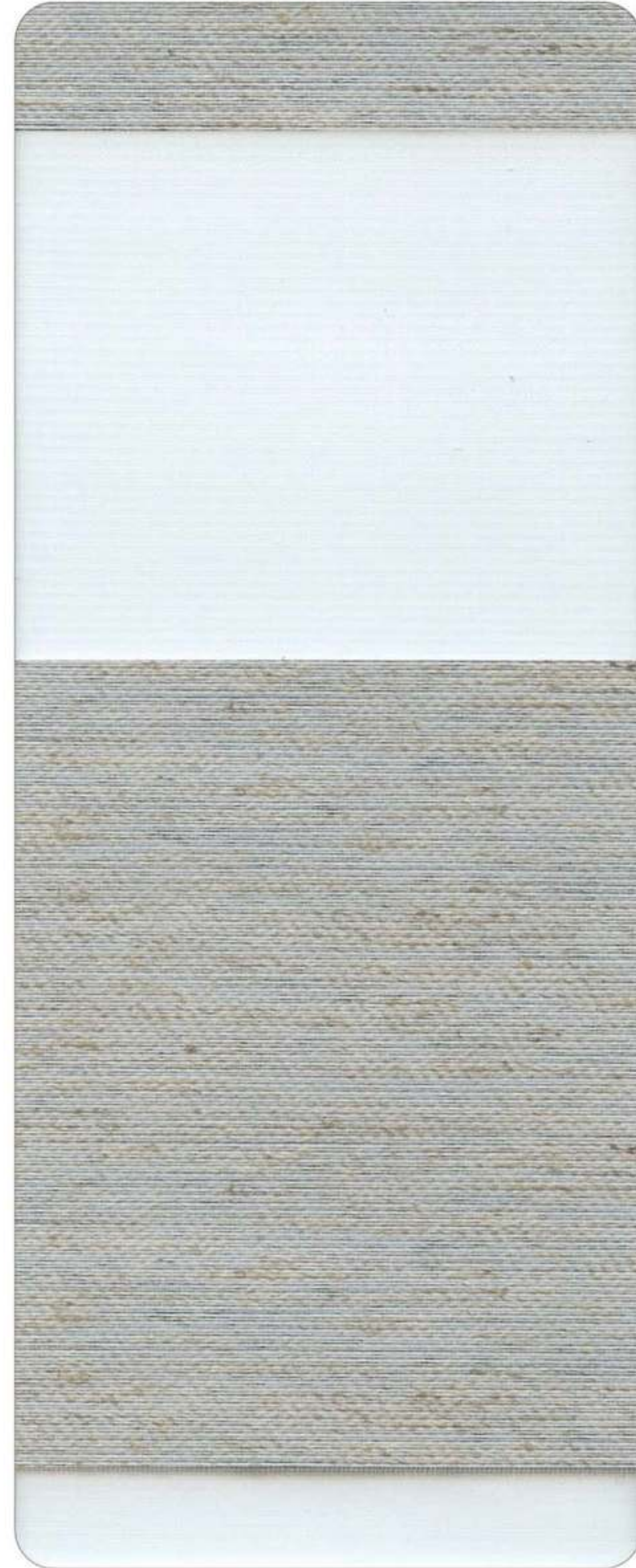

LIB 5951 Linen White 린넨 화이트



CODE NO. J200A90534

콤비 | 렌토 암막

Lento B/O

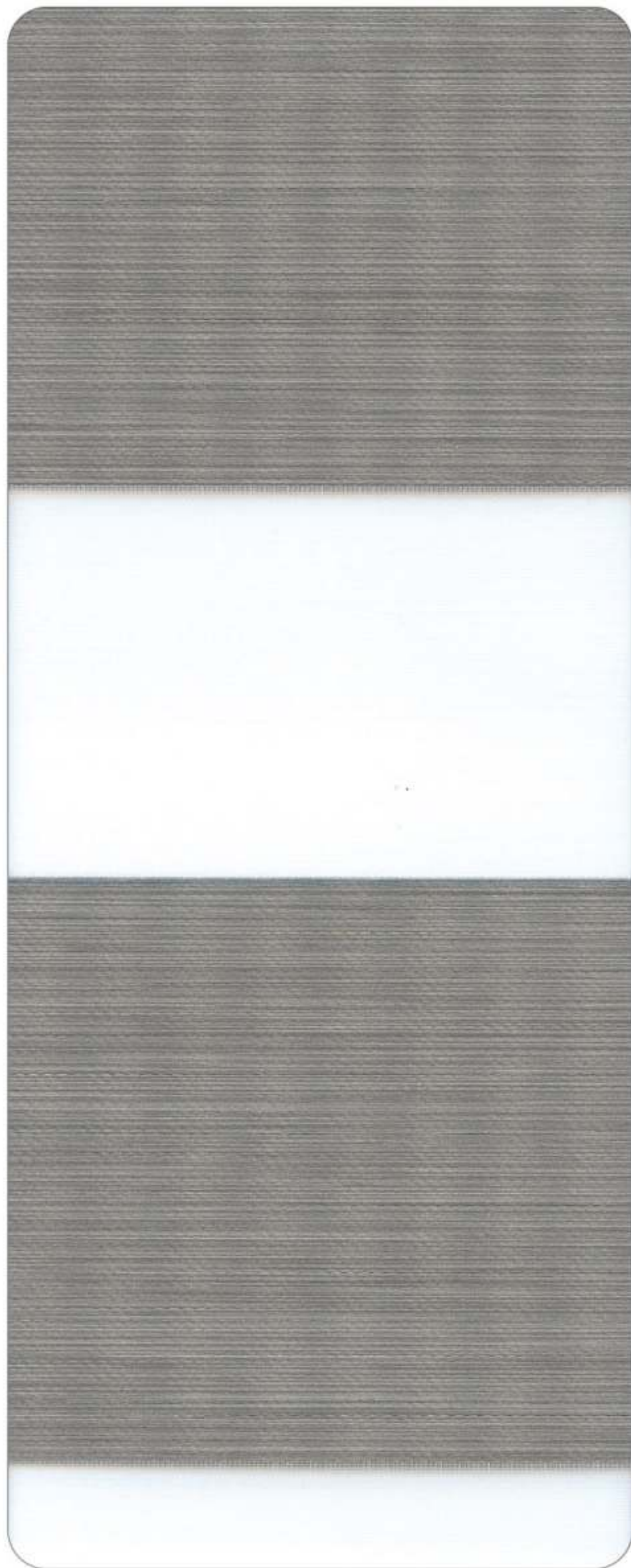

LN 4166 Dark Grey 다크 그레이

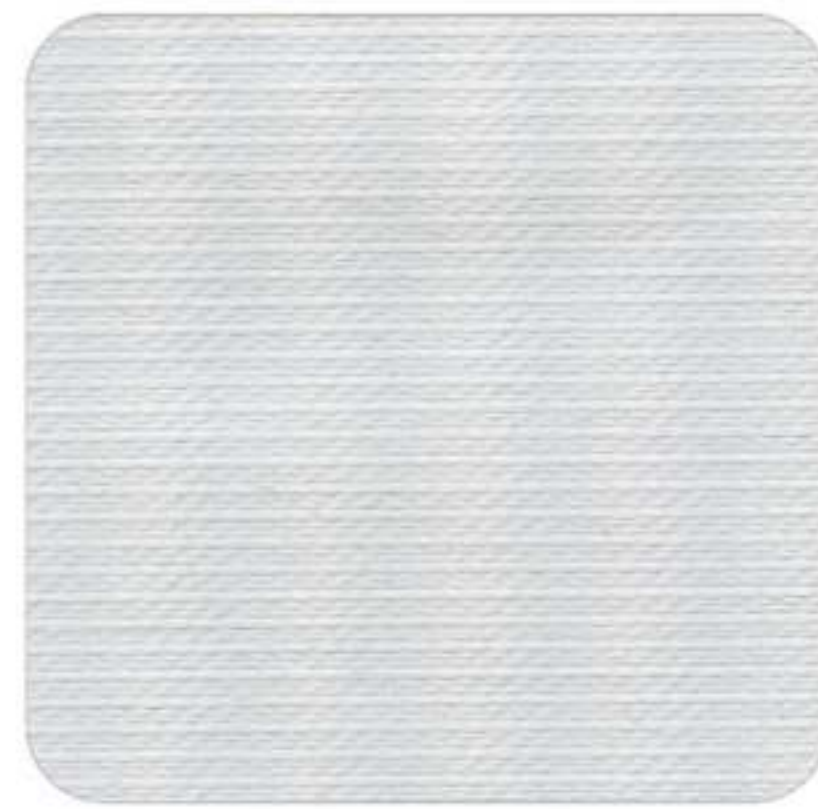

LN 4161 White 화이트



LN 4162 Ivory 아이보리



LN 4163 Ash Grey 애쉬 그레이



LN 4164 Shark Grey 샤크 그레이



LN 4167 Charcoal 차콜

COMBI BLINDS | 렌토 암막·Lento B/O

COMPOSITION	Polyester 100%	WIDTH	280cm
WEIGHT	187g / m ² ± 5 %	THICKNESS	0.49mm ± 5 %
REPEAT	Solid 75mm / Sheer 50mm	FIRE CLASSIFICATION	None



- 실내용 / 물세탁 금지 / 구겨짐 주의 / 터치블라인드 제작 가능.
- 생산 LOT에 따라 원단에 미세한 차이가 있을 수 있습니다.
- 앞장 상단의 QR코드를 스캔하시면 설치 이미지를 보실 수 있습니다.



LN 4162 Ivory 아이보리



LN 4161 White 화이트



LN 4164 Shark Grey 샤크 그레이



LN 4163 Ash Grey 애쉬 그레이



LN 4167 Charcoal 차콜

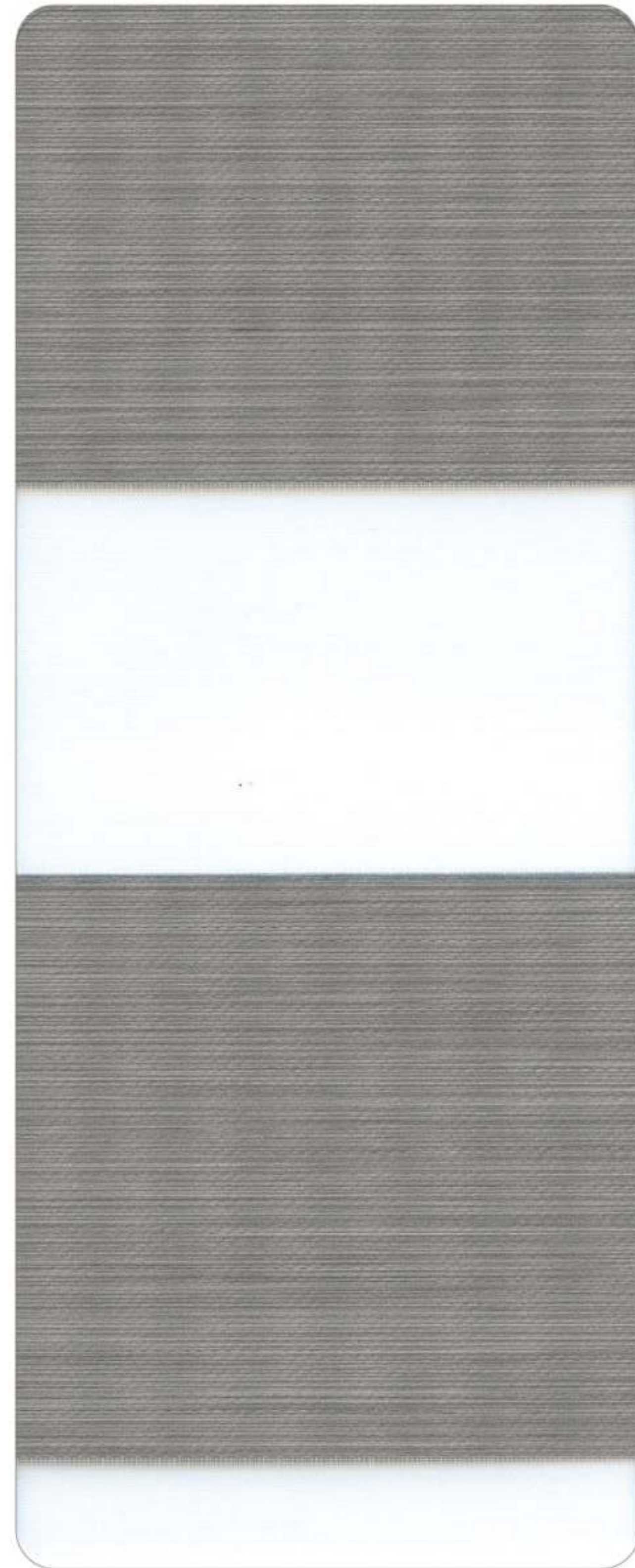

LN 4166 Dark Grey 다크 그레이



CODE NO. N190A80618

콤비 | 델로스 암막

Delos B/O

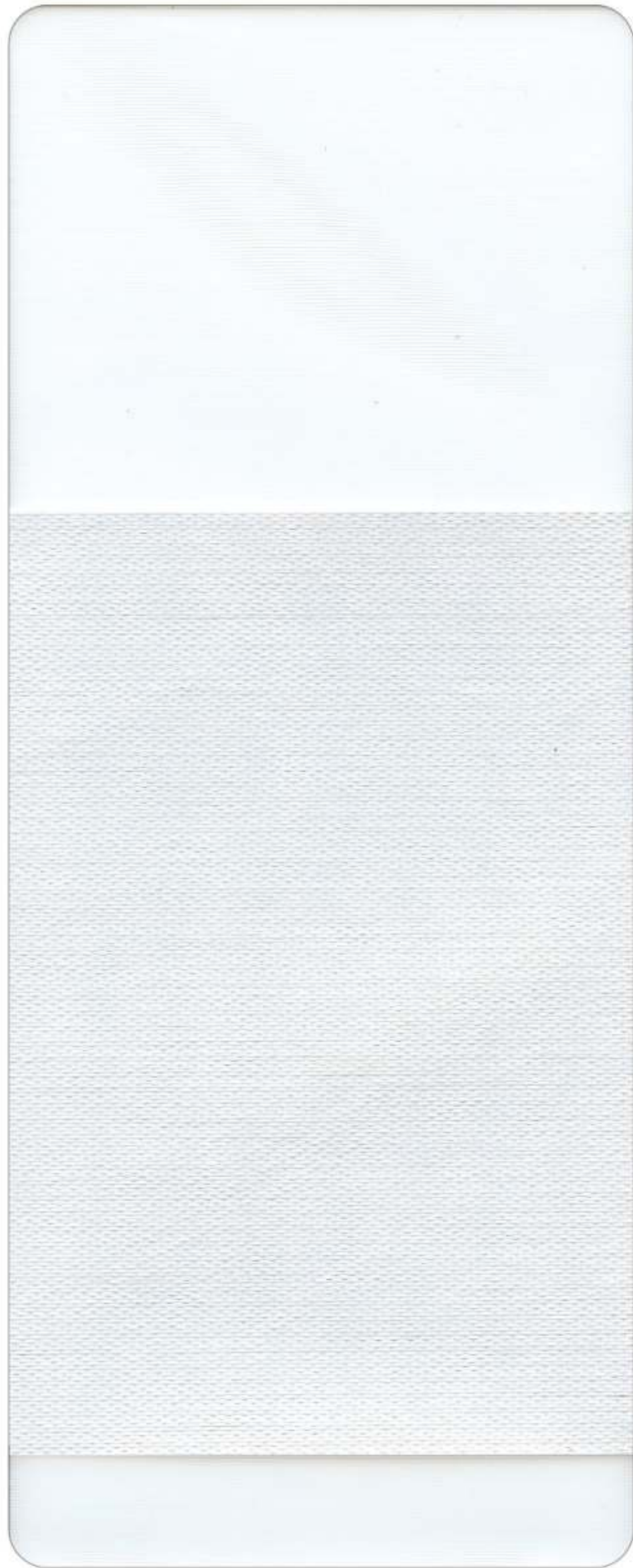

DL 7351 White 화이트

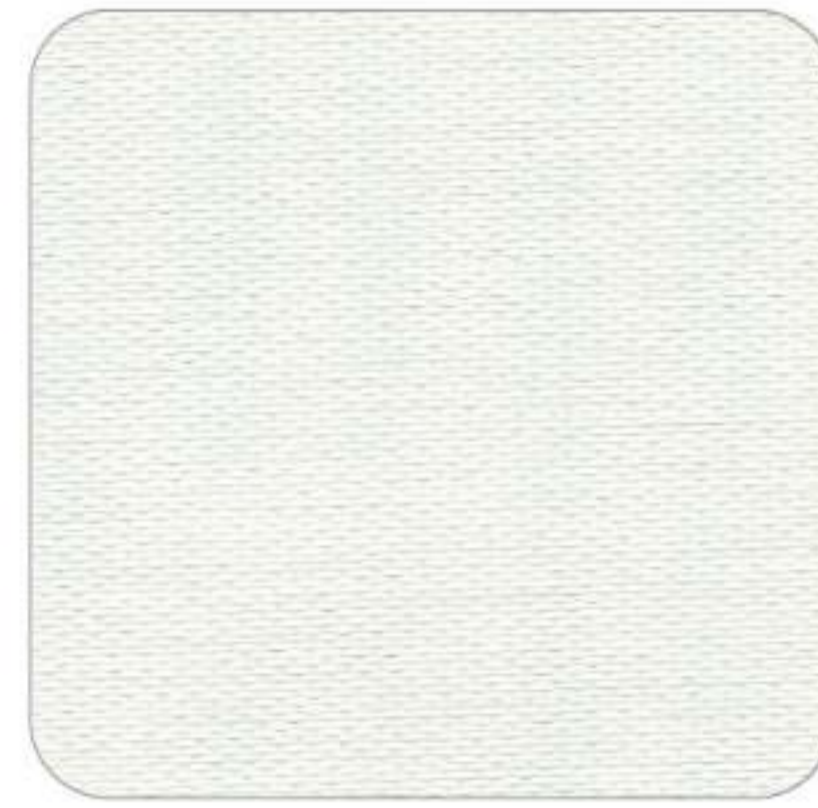

DL 7352 Cream 크림

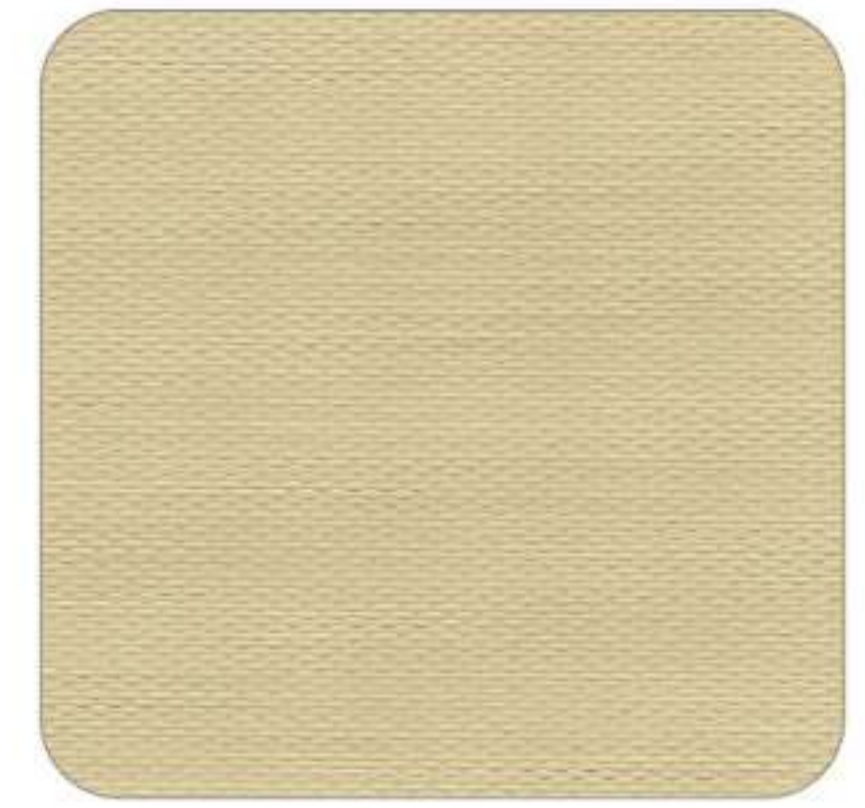

DL 7353 Beige 베이지

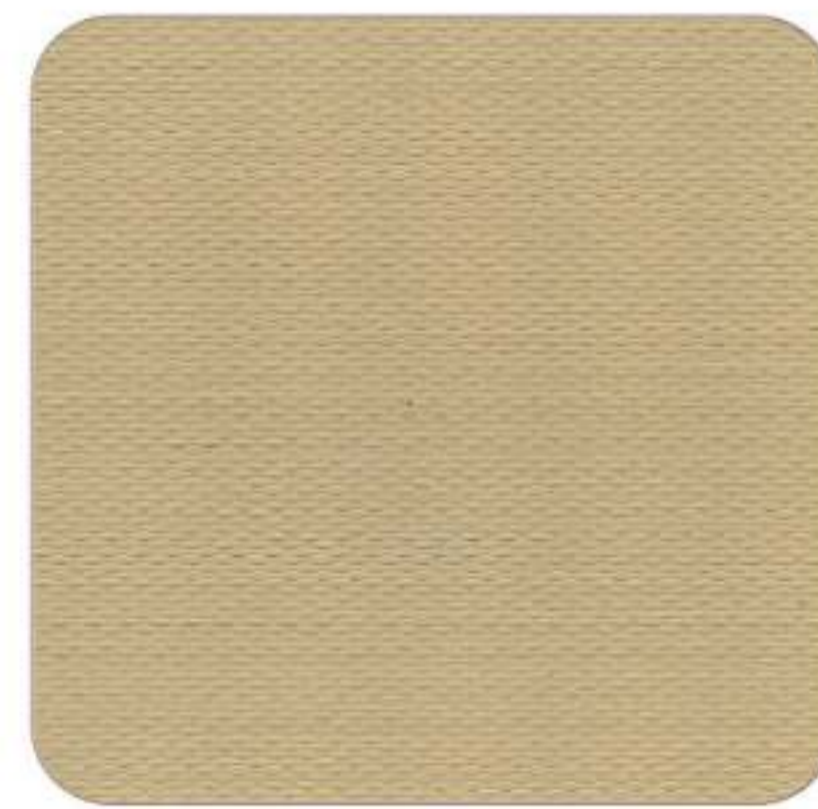

DL 7354 Light Mocha 라이트 모카



DL 7355 Grey 그레이

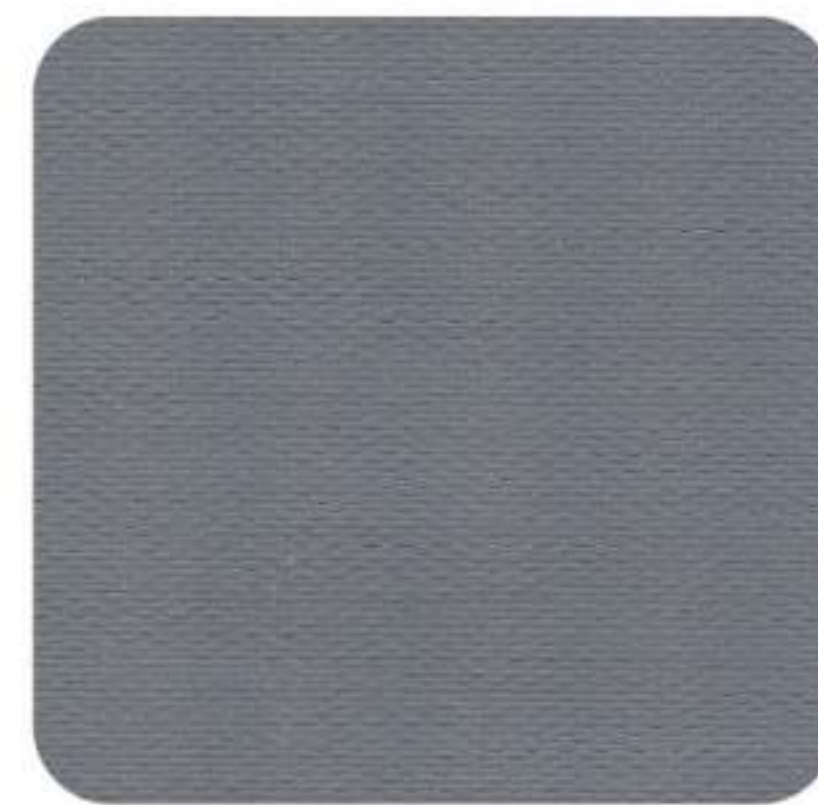

DL 7356 Steel Grey 스틸 그레이

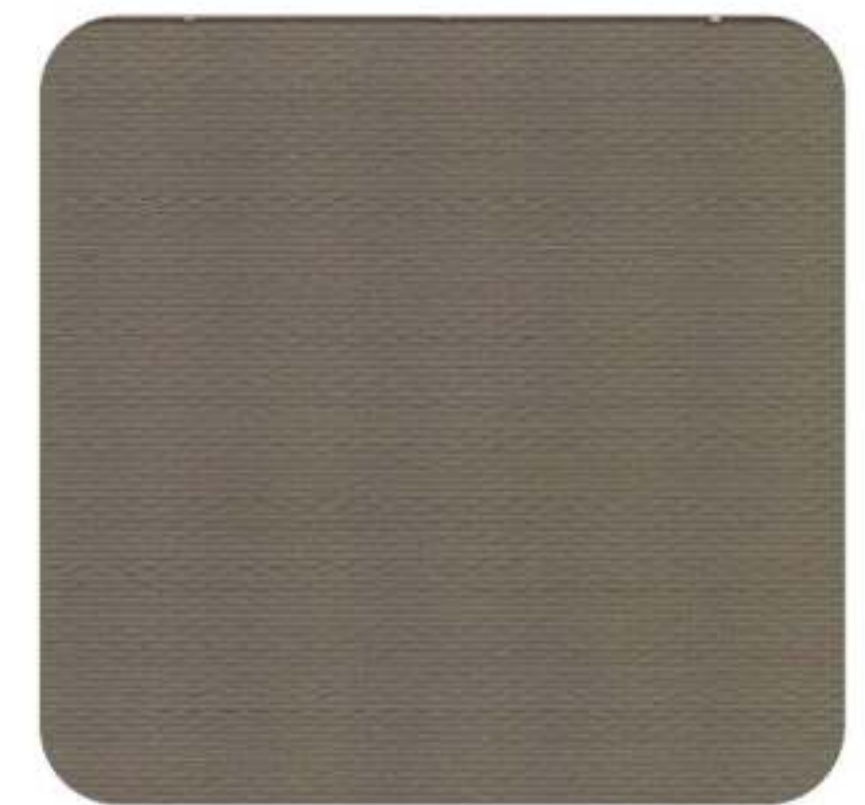

DL 7357 Dark Grey 다크 그레이

COMBI BLINDS | 델로스 암막·Delos B/O

COMPOSITION	Polyester 100%	WIDTH	280cm
WEIGHT	189g / m ² ± 5 %	THICKNESS	0.49mm ± 5 %
REPEAT	Solid 115mm / Sheer 80mm	FIRE CLASSIFICATION	None



- 실내용 / 물세탁 금지 / 구겨짐 주의 / 터치블라인드 제작 가능.
- 생산 LOT에 따라 원단에 미세한 차이가 있을 수 있습니다.
- 앞장 상단의 QR코드를 스캔하시면 설치 이미지를 보실 수 있습니다.

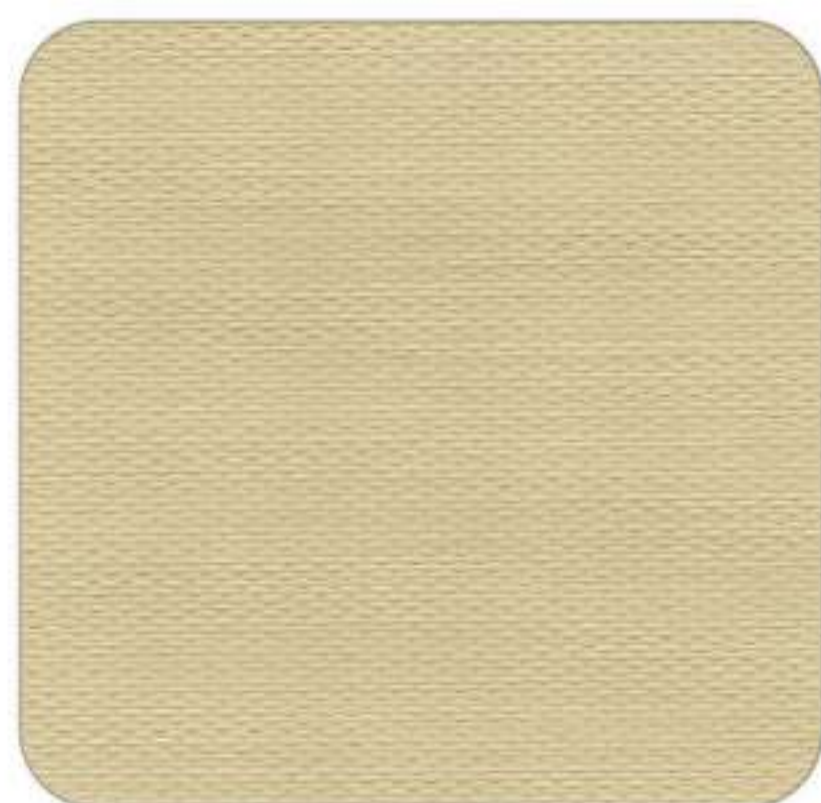

DL 7353 Beige 베이지



DL 7352 Cream 크림



DL 7355 Grey 그레이



DL 7354 Light Mocha 라이트 모카



DL 7357 Dark Grey 다크 그레이



DL 7356 Steel Grey 스틸 그레이



DL 7351 White 화이트



CODE NO. F200A90921

콤비 | 라피아 암막

Lafia B/O

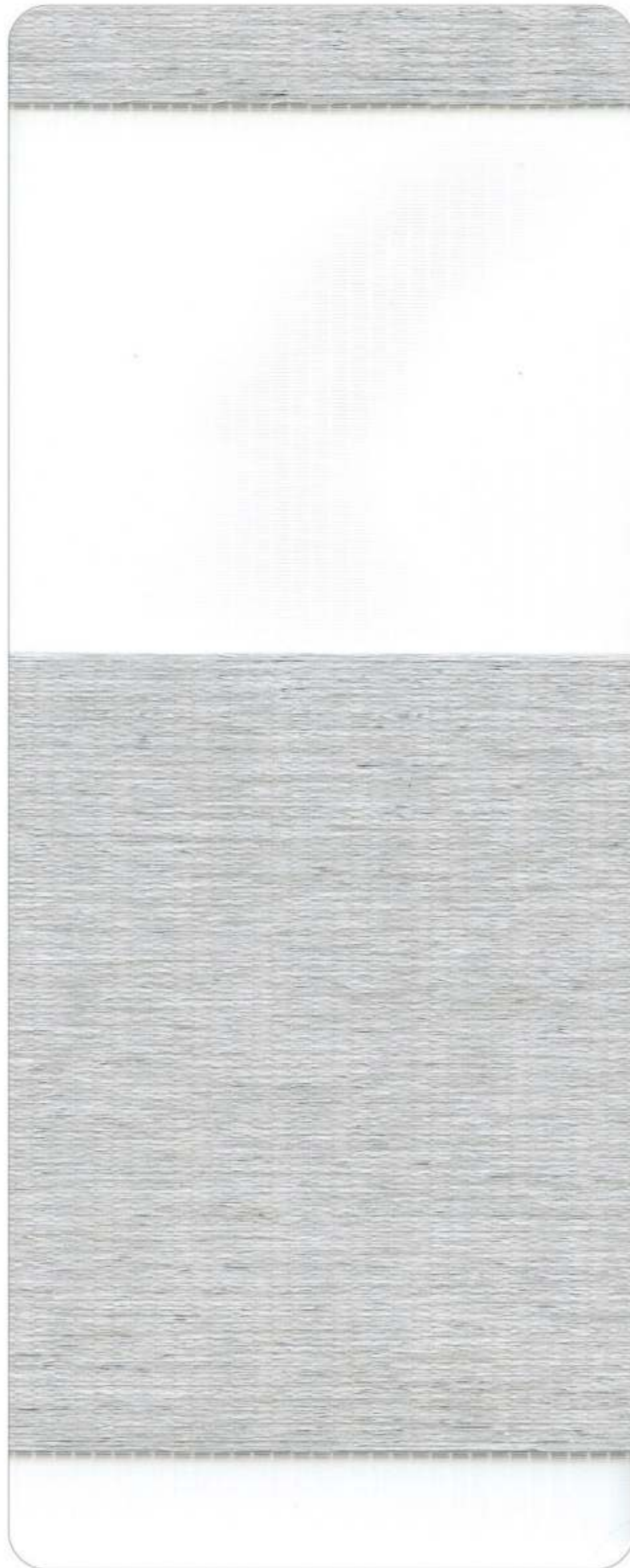

LAF 8326 Mist 미스트

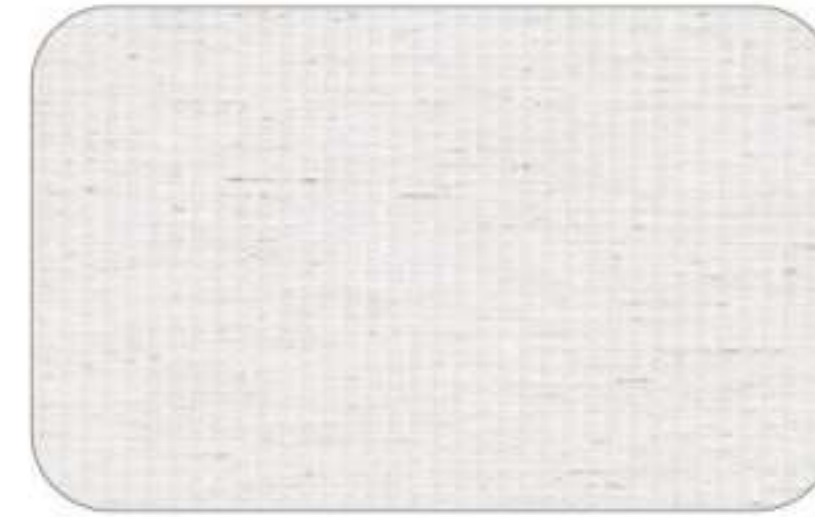

LAF 8321 White 화이트



LAF 8322 Ivory 아이보리



LAF 8323 Beige 베이지



LAF 8324 Oat 오토



LAF 8325 Taupe 토크우프



LAF 8328 Sleet 슬릿



LAF 8329 Steel Grey 스틸 그레이



LAF 8330 Shark Grey 샤크 그레이

COMBI BLINDS | 라피아 암막·Lafia B/O

COMPOSITION	Polyester 100%	WIDTH	280cm
WEIGHT	177g / m ² ± 5 %	THICKNESS	0.50mm ± 5 %
REPEAT	Solid 100mm / Sheer 70mm	FIRE CLASSIFICATION	None



- 실내용 / 물세탁 금지 / 구겨짐 주의 / 터치블라인드 제작 가능.
- 생산 LOT에 따라 원단에 미세한 차이가 있을 수 있습니다.
- 앞장 상단의 QR코드를 스캔하시면 설치 이미지를 보실 수 있습니다.



LAF 8322 Ivory 아이보리



LAF 8321 White 화이트



LAF 8324 Oat 오토



LAF 8323 Beige 베이지



LAF 8328 Sleet 슬릿



LAF 8325 Taupe 토크우프

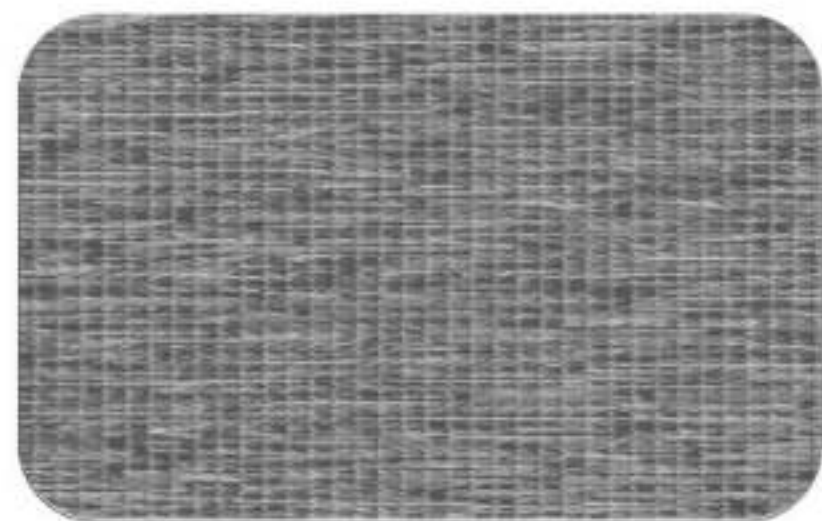

LAF 8330 Shark Grey 샤크 그레이

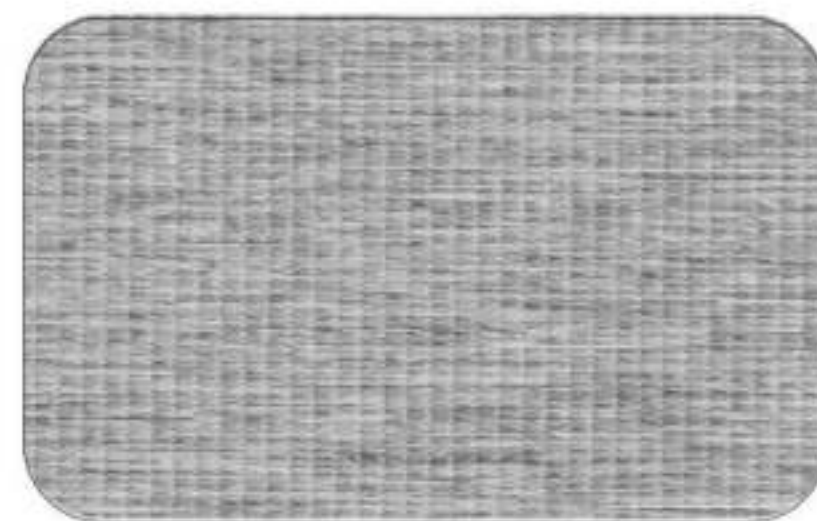

LAF 8329 Steel Grey 스틸 그레이

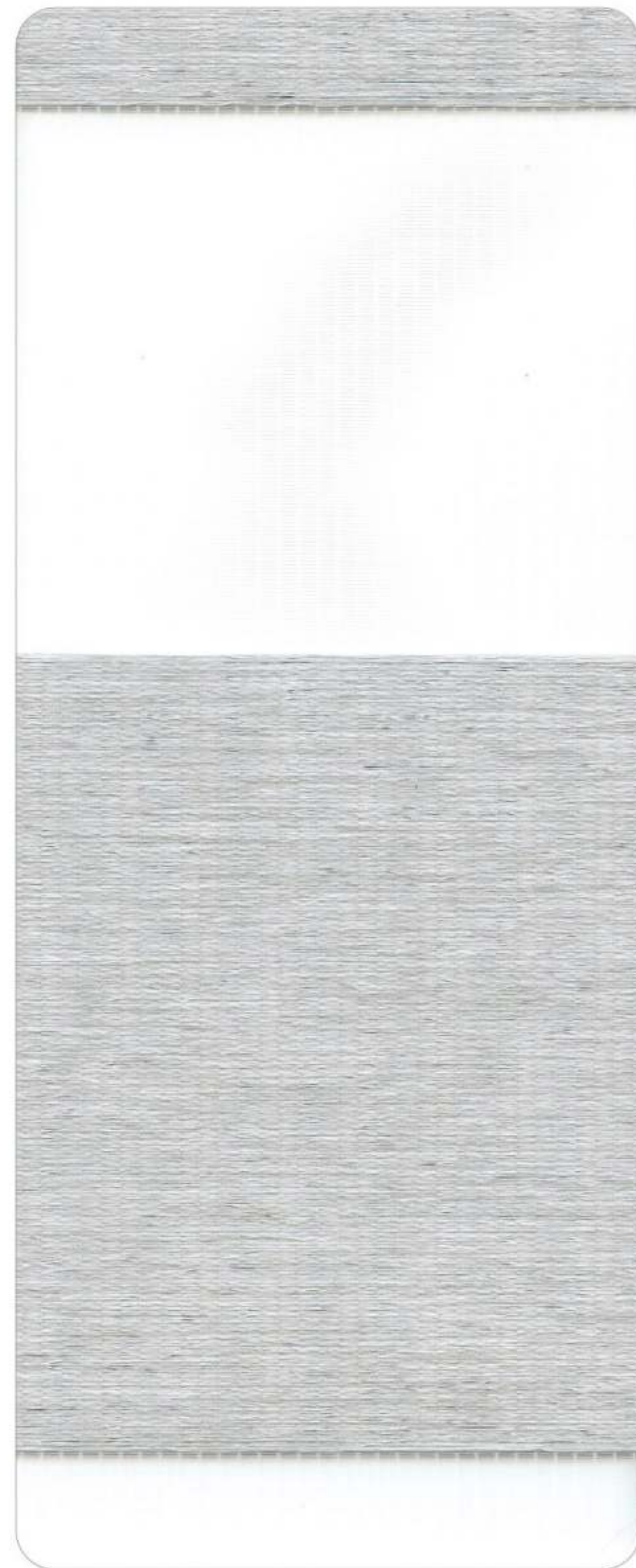

LAF 8326 Mist 미스트



CODE NO. E200A90337

콤비 | 데이지 암막

Daisy B/O



DA 5206 Stone Grey 스톤 그레이

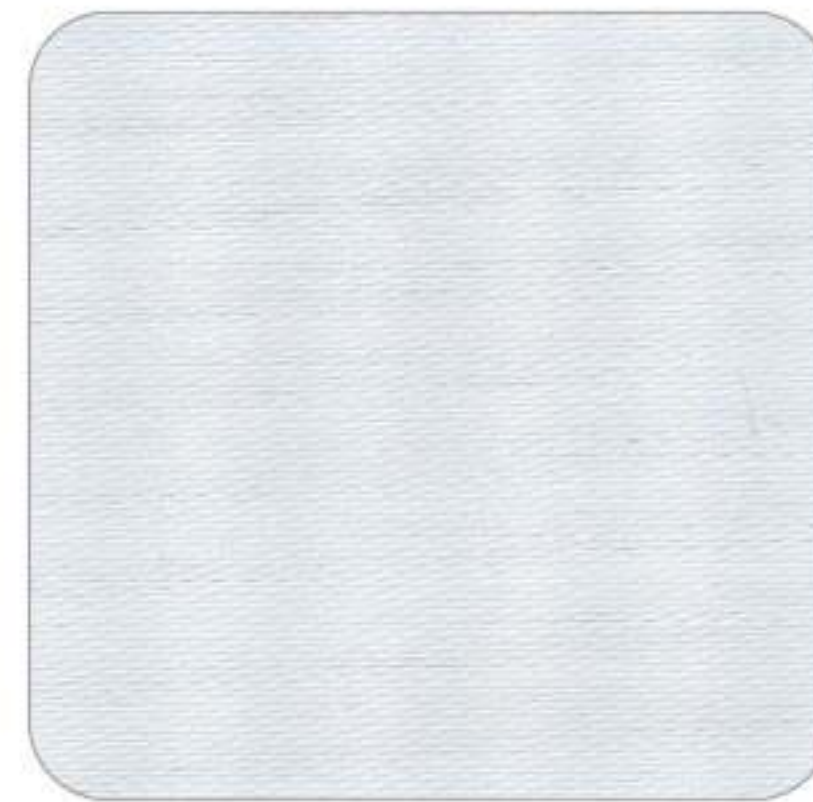

DA 5201 White 화이트

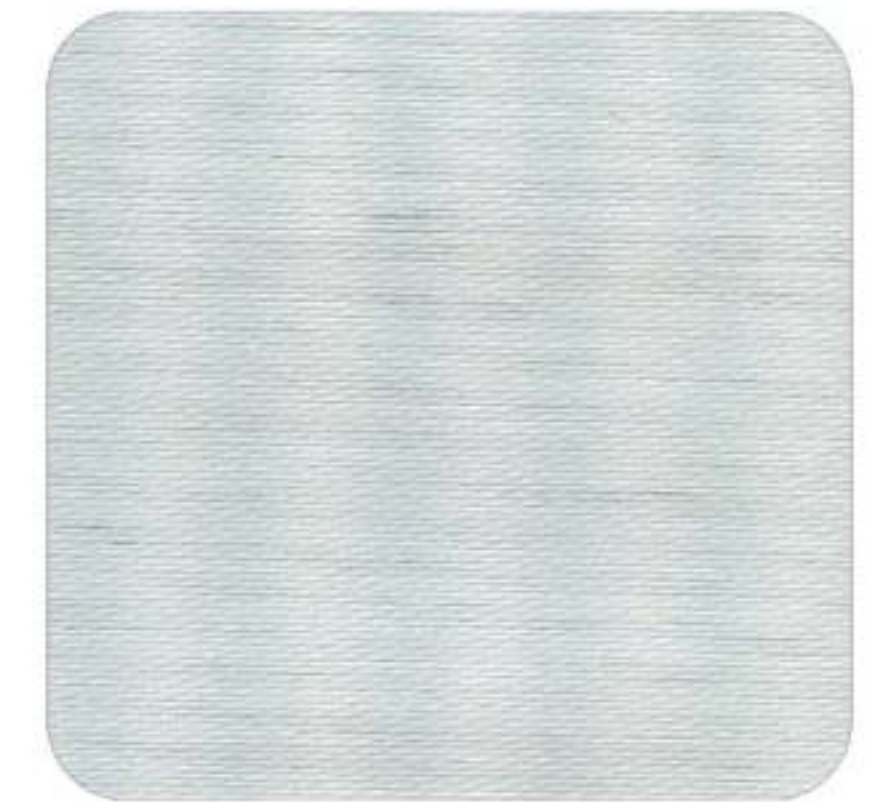

DA 5202 Ivory 아이보리



DA 5203 Beige 베이지



DA 5209 Brown 브라운



DA 5205 Silver Grey 실버 그레이



DA 5207 Charcoal 차콜

COMBI BLINDS | 데이지 암막·Daisy B/O

COMPOSITION	Polyester 100%	WIDTH	280cm
WEIGHT	150g / m ² ± 5 %	THICKNESS	0.42mm ± 5 %
REPEAT	Solid 100mm / Sheer 70mm	FIRE CLASSIFICATION	None



- 실내용 / 물세탁 금지 / 구겨짐 주의 / 터치블라인드 제작 가능.
- 생산 LOT에 따라 원단에 미세한 차이가 있을 수 있습니다.
- 앞장 상단의 QR코드를 스캔하시면 설치 이미지를 보실 수 있습니다.



DA 5202 Ivory 아이보리

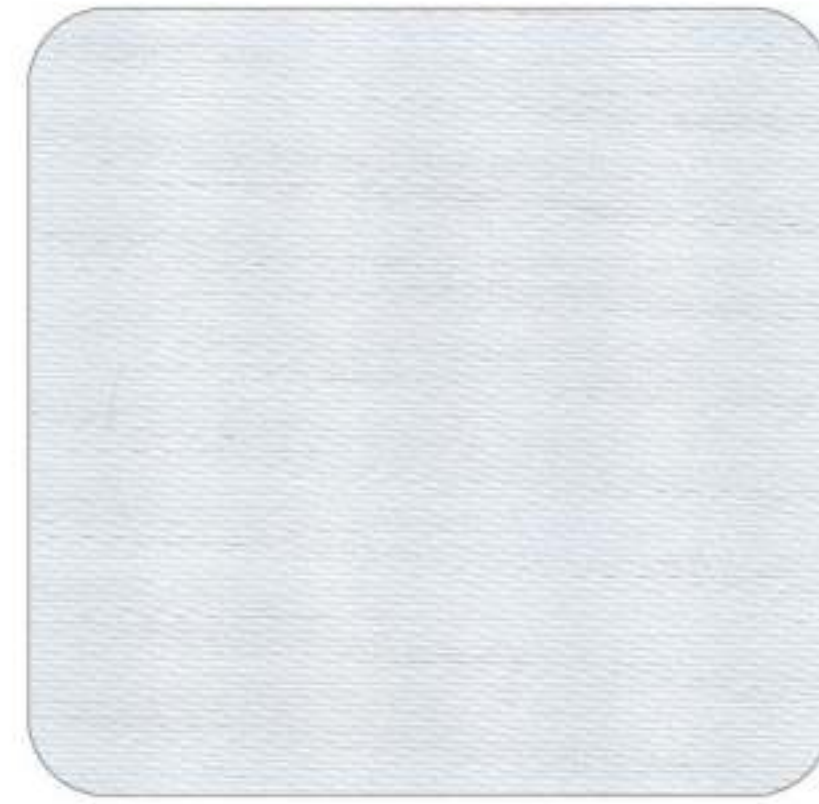

DA 5201 White 화이트



DA 5209 Brown 브라운



DA 5203 Beige 베이지



DA 5207 Charcoal 차콜



DA 5205 Silver Grey 실버 그레이



DA 5206 Stone Grey 스톤 그레이



CODE NO. J180A70800

콤비 | 안도라 암막

Andorra B/O

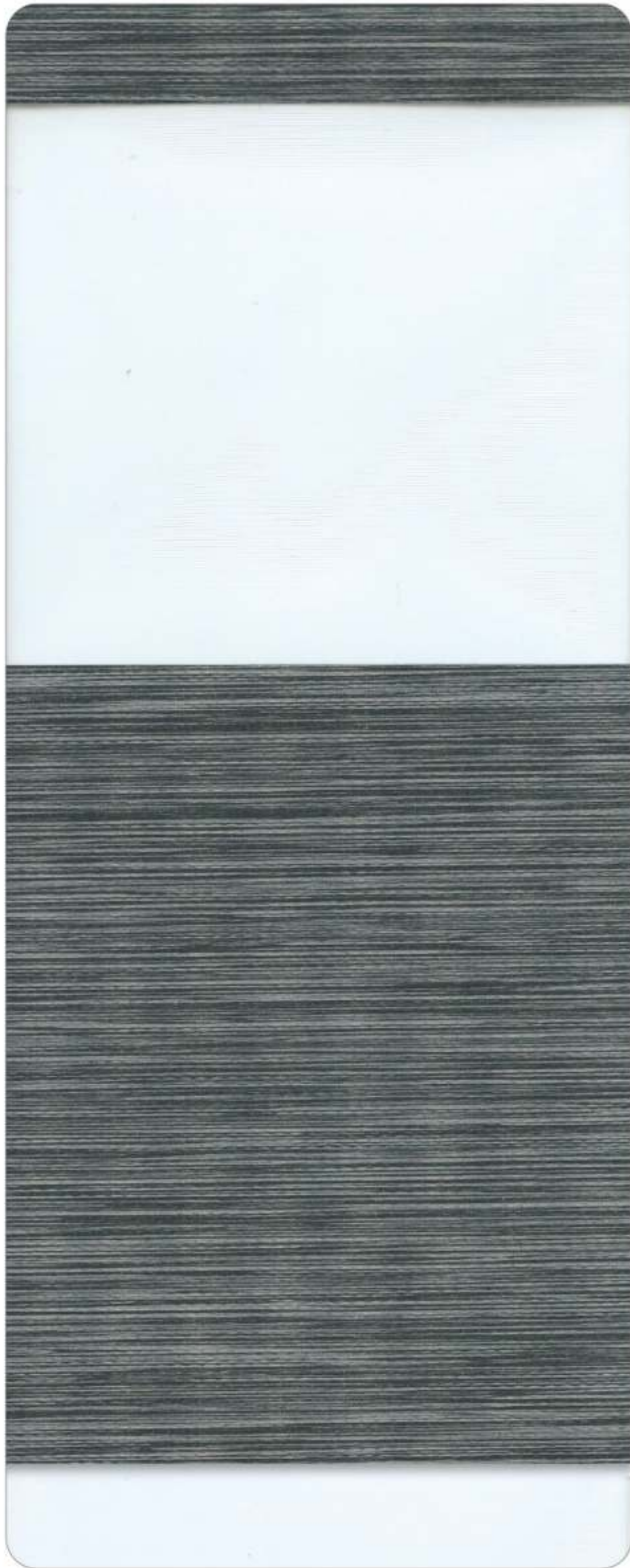

AR 8478 Shark Grey 샤크 그레이

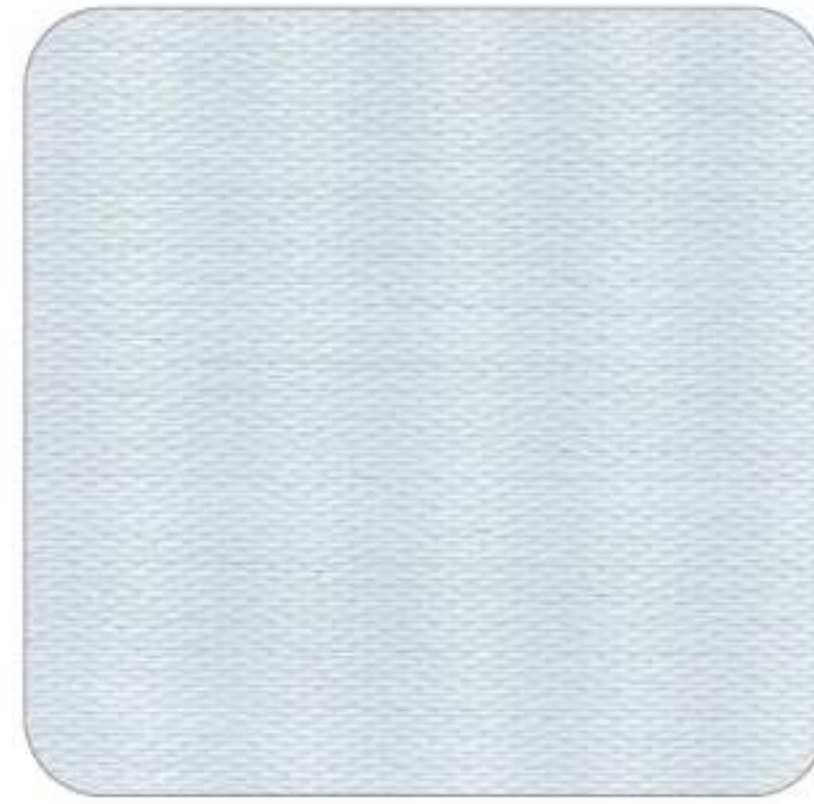

AR 8471 White 화이트



AR 8472 Ivory 아이보리



AR 8473 Grey 그레이



AR 8475 Seaweed 씨위드



AR 8476 Khaki Brown 카키 브라운

COMBI BLINDS | 안도라 암막·Andorra B/O

COMPOSITION	Polyester 100%	WIDTH	280cm
WEIGHT	151g / m ² ± 5 %	THICKNESS	0.42mm ± 5 %
REPEAT	Solid 100mm / Sheer 70mm	FIRE CLASSIFICATION	None



- 실내용 / 물세탁 금지 / 구겨짐 주의 / 터치블라인드 제작 가능.
- 생산 LOT에 따라 원단에 미세한 차이가 있을 수 있습니다.
- 앞장 상단의 QR코드를 스캔하시면 설치 이미지를 보실 수 있습니다.



AR 8472 Ivory 아이보리

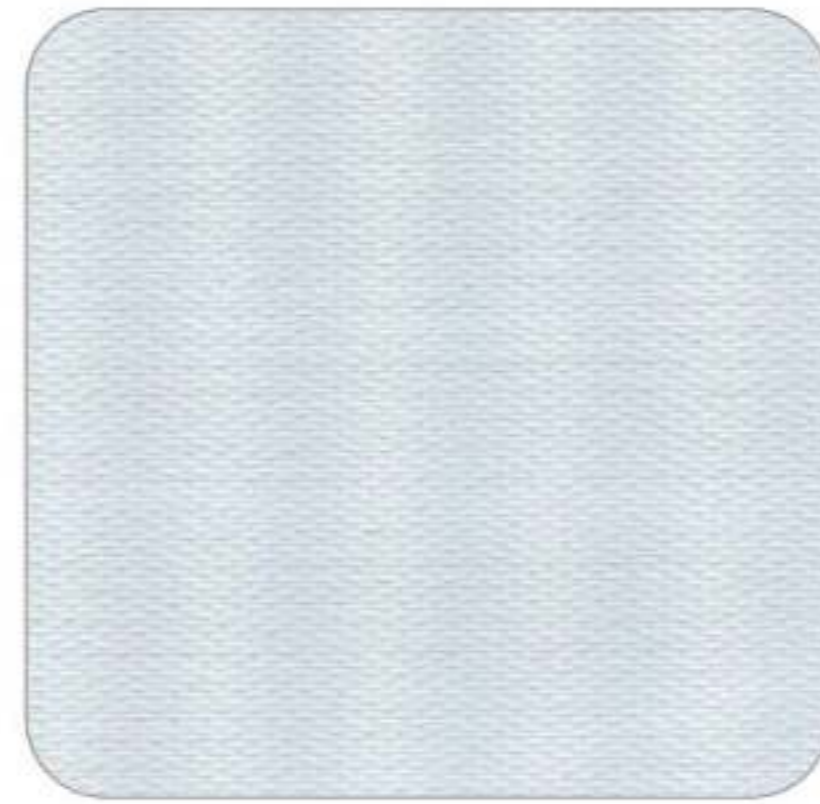

AR 8471 White 화이트



AR 8475 Seaweed 씨위드



AR 8473 Grey 그레이



AR 8476 Khaki Brown 카키 브라운

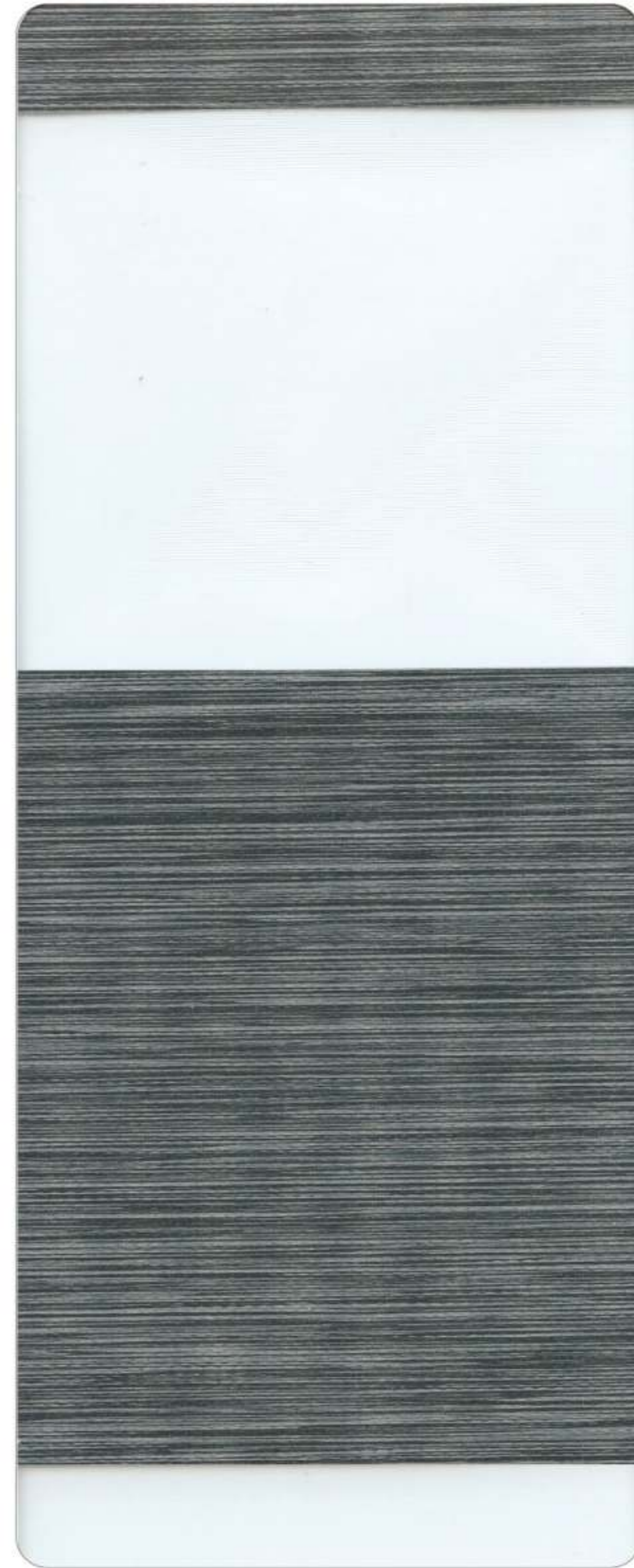

AR 8478 Shark Grey 샤크 그레이



CODE NO. H180A70534

콤비 | 카라만 암막



Karaman B/O



KA 8045 Grey 그레이

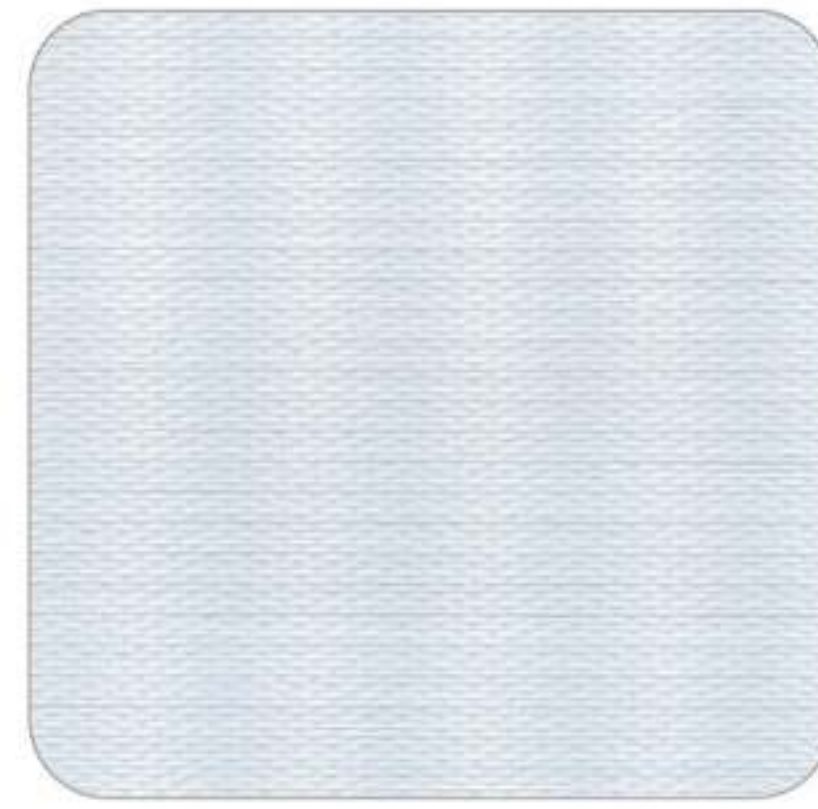

KA 8041 White 화이트



KA 8042 Ivory 아이보리



KA 8043 Beige 베이지



KA 8044 Brown 브라운



KA 8046 Dark Grey 다크 그레이



KA 8047 Charcoal 차콜

COMBI BLINDS | 카라만 암막·Karaman B/O

COMPOSITION	Polyester 100%	WIDTH	280cm
WEIGHT	149g / m ² ± 5 %	THICKNESS	0.42mm ± 5 %
REPEAT	Solid 100mm / Sheer 70mm	FIRE CLASSIFICATION	None



- 실내용 / 물세탁 금지 / 구겨짐 주의 / 터치블라인드 제작 가능.
- 생산 LOT에 따라 원단에 미세한 차이가 있을 수 있습니다.
- 앞장 상단의 QR코드를 스캔하시면 설치 이미지를 보실 수 있습니다.



KA 8042 Ivory 아이보리



KA 8041 White 화이트

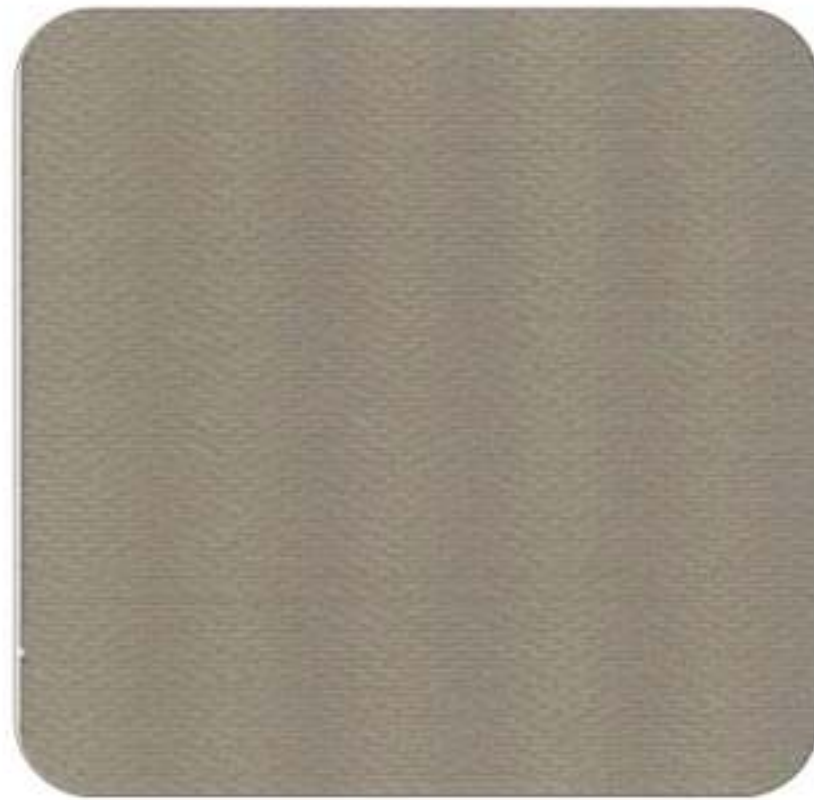

KA 8044 Brown 브라운



KA 8043 Beige 베이지



KA 8047 Charcoal 차콜



KA 8046 Dark Grey 다크 그레이



KA 8045 Grey 그레이

CODE NO. J210B00241

콤비 | 올리브
Olive

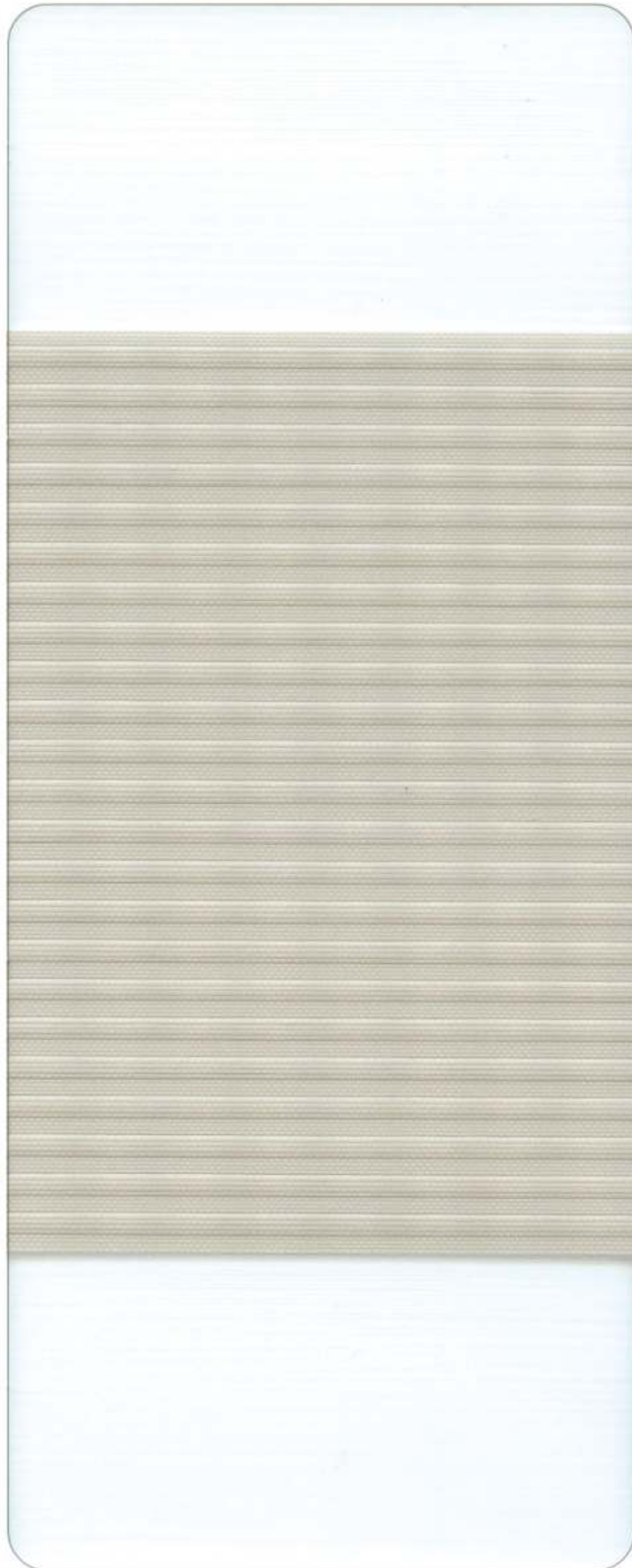

OL 3318 Silver Grey 실버 그레이



OL 3311 White 화이트



OL 3312 Cream 크림



OL 3313 Sand 샌드



OL 3314 Latte 라떼



OL 3316 Acorn 아콘



OL 3317 Charcoal 차콜



OL 3315 Shark Grey 샤크 그레이

COMBI BLINDS | 올리브·Olive

COMPOSITION	Polyester 100%	WIDTH	280cm
WEIGHT	140g / m ² ± 5 %	THICKNESS	0.61mm ± 5 %
REPEAT	Solid 115mm / Sheer 80mm	FIRE CLASSIFICATION	None



- 실내용 / 물세탁 금지 / 구겨짐 주의 / 터치블라인드 제작 가능.
- 생산 LOT에 따라 원단에 미세한 차이가 있을 수 있습니다.
- 앞장 상단의 QR코드를 스캔하시면 설치 이미지를 보실 수 있습니다.



OL 3312 Cream 크림



OL 3311 White 화이트



OL 3314 Latte 라떼



OL 3313 Sand 샌드



OL 3317 Charcoal 차콜



OL 3316 Acorn 아콘



OL 3315 Shark Grey 샤크 그레이

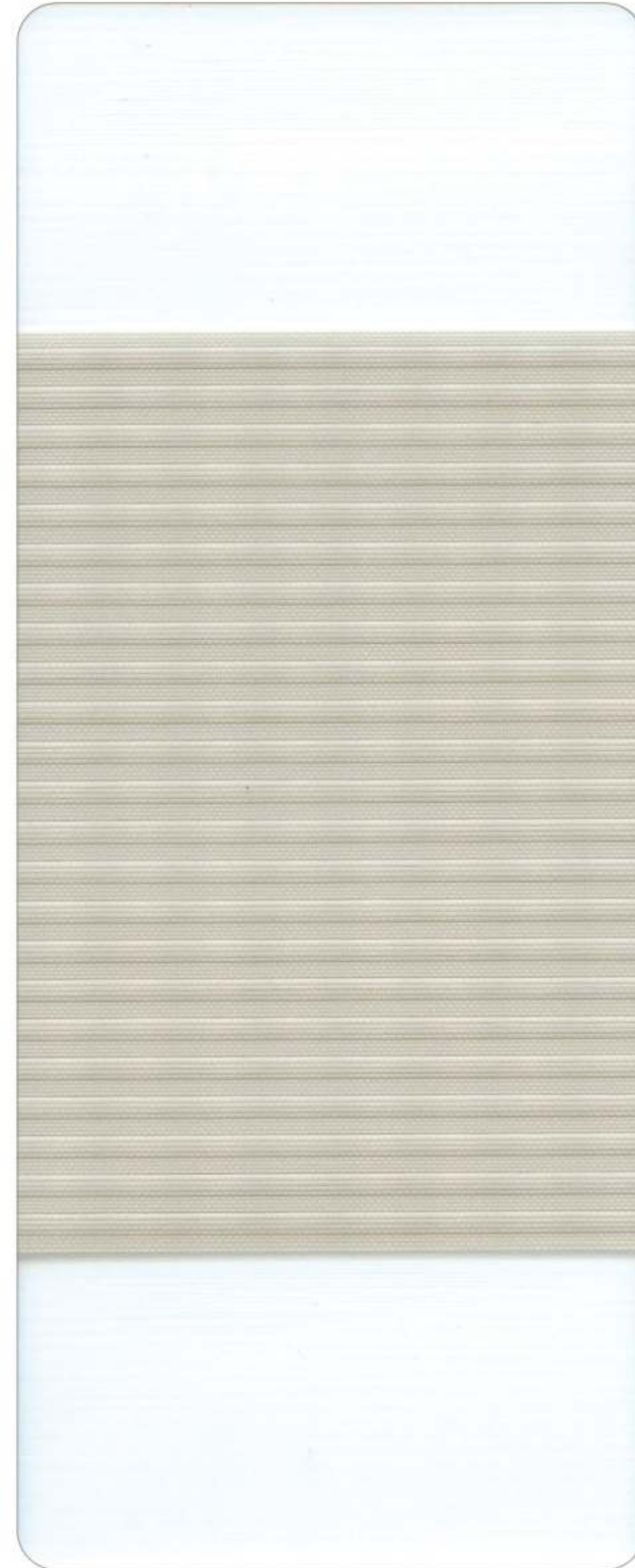

OL 3318 Silver Grey 실버 그레이



CODE NO. W180A70129

콤비 | 몰타

Malta

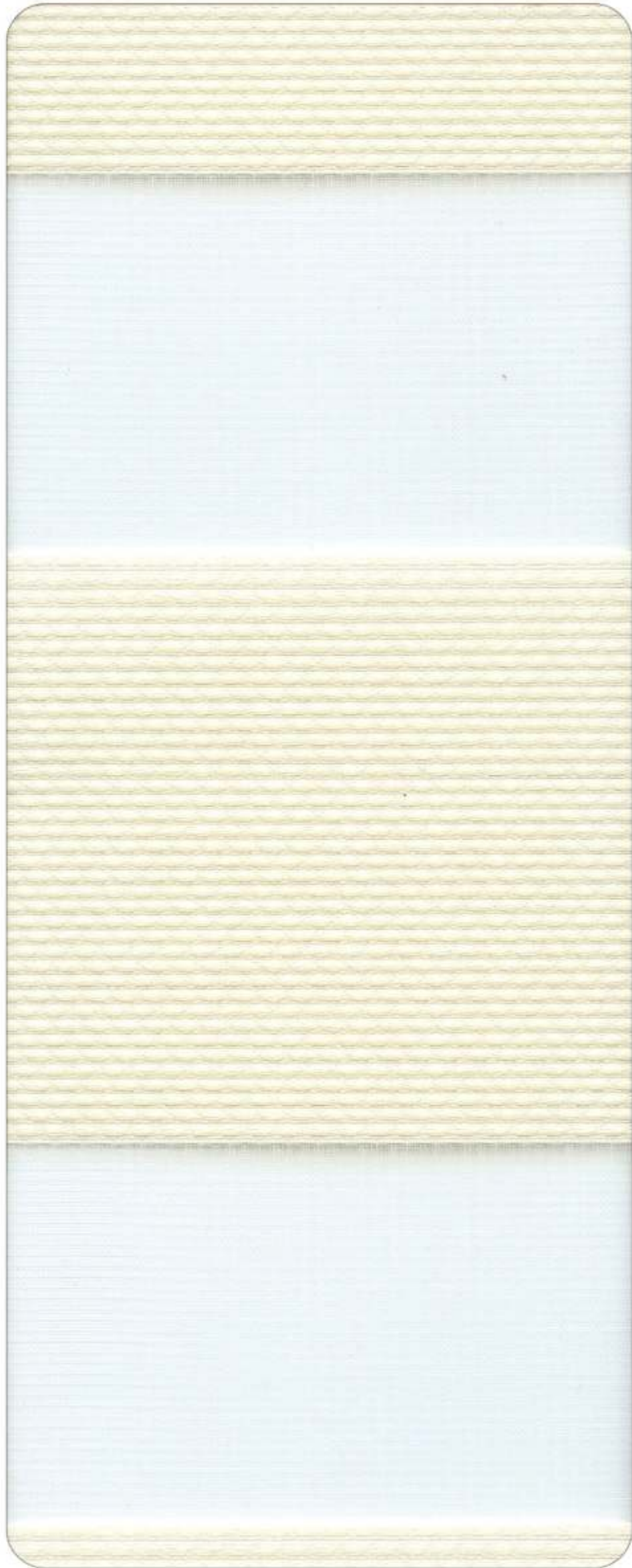

MOL 9352 Ivory 아이보리



MOL 9351 White 화이트



MOL 9353 Sand 샌드

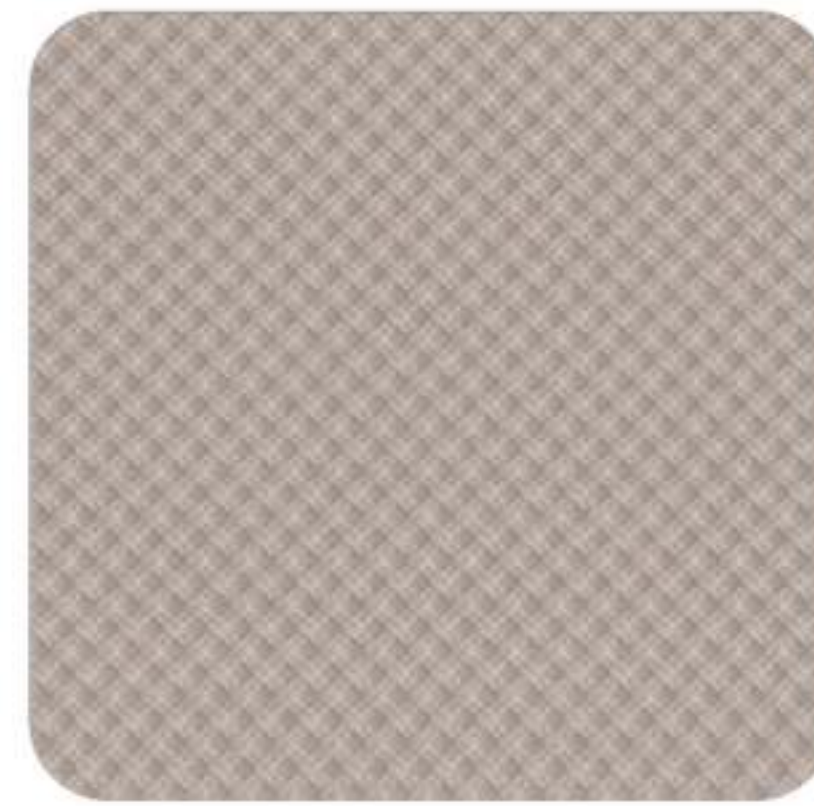

MOL 9354 Brown 브라운



MOL 9355 Light Grey 라이트 그레이

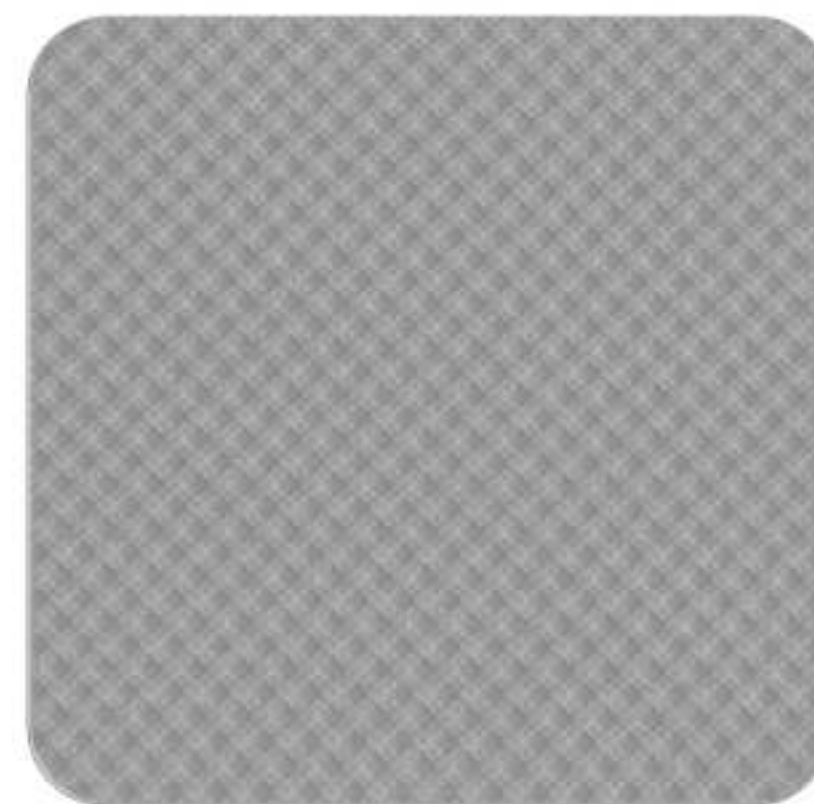

MOL 9356 Dark Grey 다크 그레이

COMBI BLINDS | 몰타·Malta

COMPOSITION	Polyester 100%	WIDTH	280cm
WEIGHT	126g / m ² ± 5 %	THICKNESS	0.37mm ± 5 %
REPEAT	Solid 75mm / Sheer 50mm	FIRE CLASSIFICATION	None



- 실내용 / 물세탁 금지 / 구겨짐 주의 / 터치블라인드 제작 가능.
- 생산 LOT에 따라 원단에 미세한 차이가 있을 수 있습니다.
- 앞장 상단의 QR코드를 스캔하시면 설치 이미지를 보실 수 있습니다.



MOL 9353 Sand 샌드

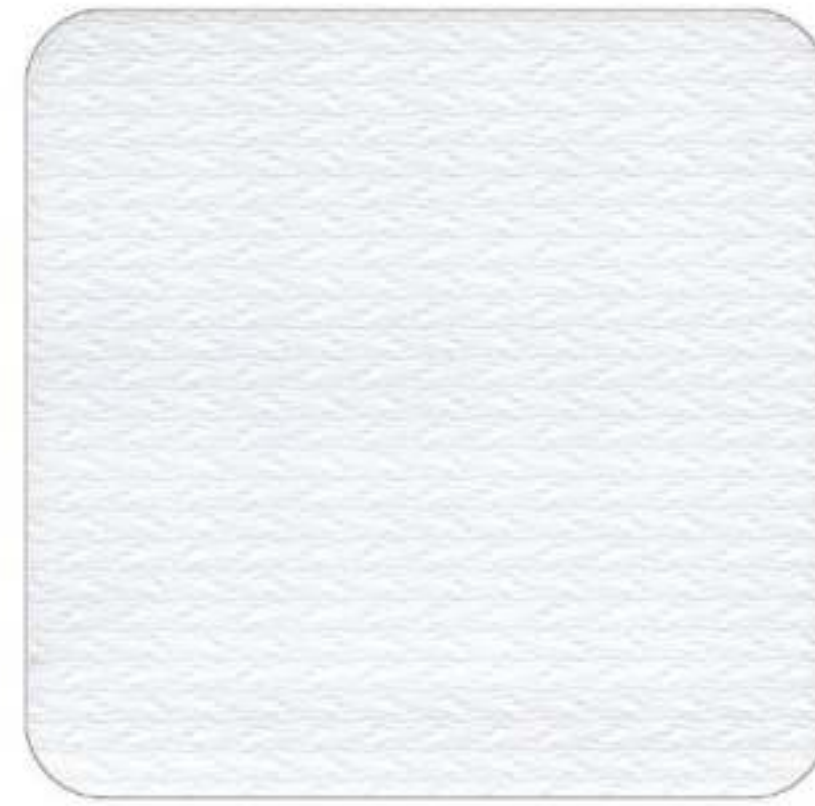

MOL 9351 White 화이트



MOL 9355 Light Grey 라이트 그레이



MOL 9354 Brown 브라운



MOL 9356 Dark Grey 다크 그레이

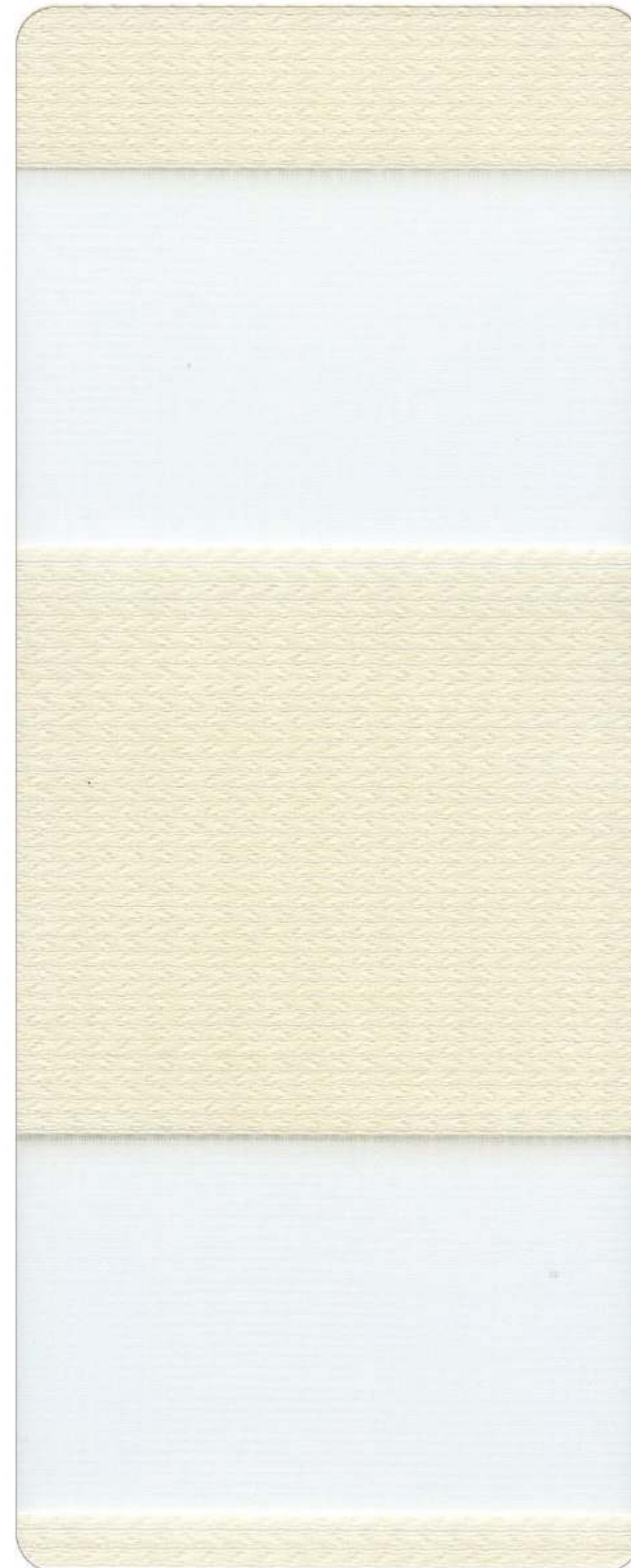

MOL 9352 Ivory 아이보리

CODE NO. M180A70337

콤비 | 크라비
Krabi

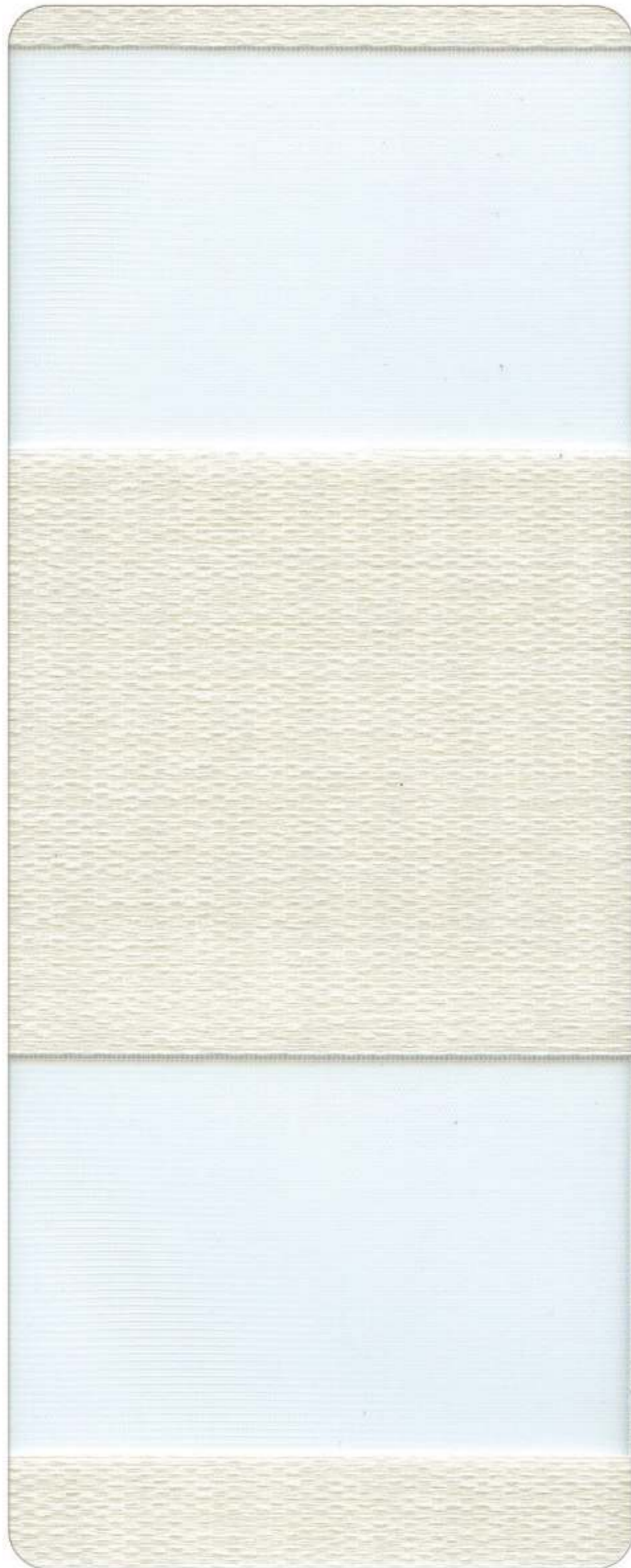

KB 2652 Ivory 아이보리



KB 2651 White 화이트



KB 2653 Beige 베이지



KB 2654 Light Grey 라이트 그레이



KB 2655 Seed 씨드

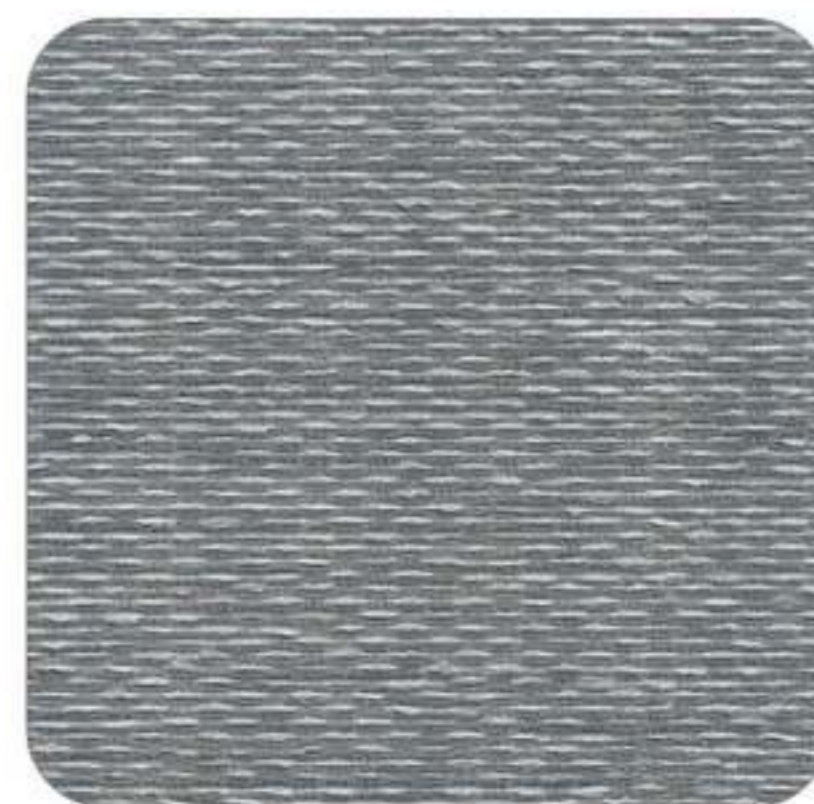

KB 2656 Dark Grey 다크 그레이

COMBI BLINDS | 크라비·Krabi

COMPOSITION	Polyester 100%	WIDTH	280cm
WEIGHT	108g / m ² ± 5 %	THICKNESS	0.43mm ± 5 %
REPEAT	Solid 75mm / Sheer 50mm	FIRE CLASSIFICATION	None



- 실내용 / 물세탁 금지 / 구겨짐 주의 / 터치블라인드 제작 가능.
- 생산 LOT에 따라 원단에 미세한 차이가 있을 수 있습니다.
- 앞장 상단의 QR코드를 스캔하시면 설치 이미지를 보실 수 있습니다.



KB 2653 Beige 베이지



KB 2651 White 화이트



KB 2655 Seed 씨드



KB 2654 Light Grey 라이트 그레이



KB 2656 Dark Grey 다크 그레이



KB 2652 Ivory 아이보리

CODE NO. T180A70321

콤비 | 린넨 지브라

Linen Zebra



LZ 6051 White 화이트



LZ 6052 Ivory 아이보리



LZ 6053 Beige 베이지

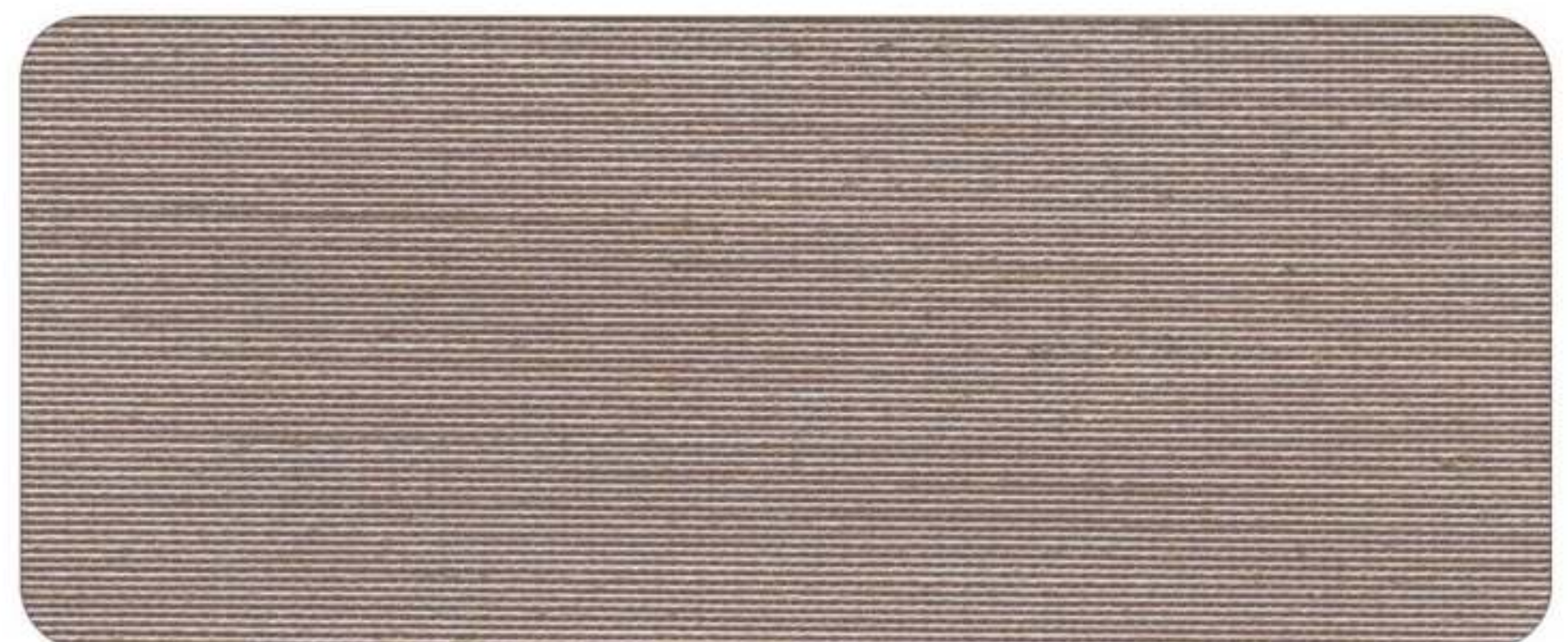

LZ 6054 Brown 브라운

COMBI BLINDS | 린넨 지브라·Linen Zebra

COMPOSITION	Polyester 100%	WIDTH	280cm
WEIGHT	106g / m ² ± 5 %	THICKNESS	0.33mm ± 5 %
REPEAT	Solid 100mm / Sheer 70mm	FIRE CLASSIFICATION	None



- 실내용 / 물세탁 금지 / 구겨짐 주의 / 터치블라인드 제작 가능.
- 생산 LOT에 따라 원단에 미세한 차이가 있을 수 있습니다.
- 앞장 상단의 QR코드를 스캔하시면 설치 이미지를 보실 수 있습니다.



LZ 6052 Ivory 아이보리



LZ 6053 Beige 베이지

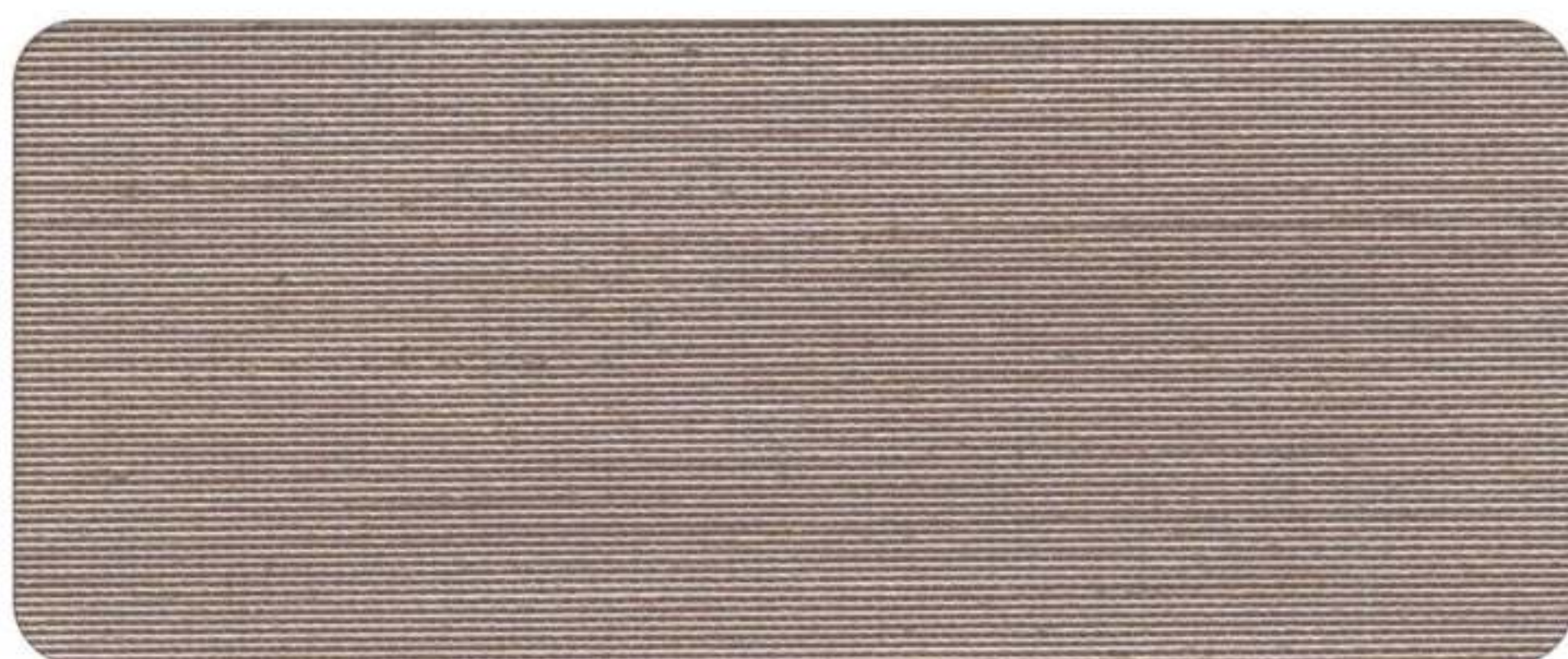

LZ 6054 Brown 브라운



LZ 6051 White 화이트



CODE NO. R175A65811

콤비 | 루이스

Lewis

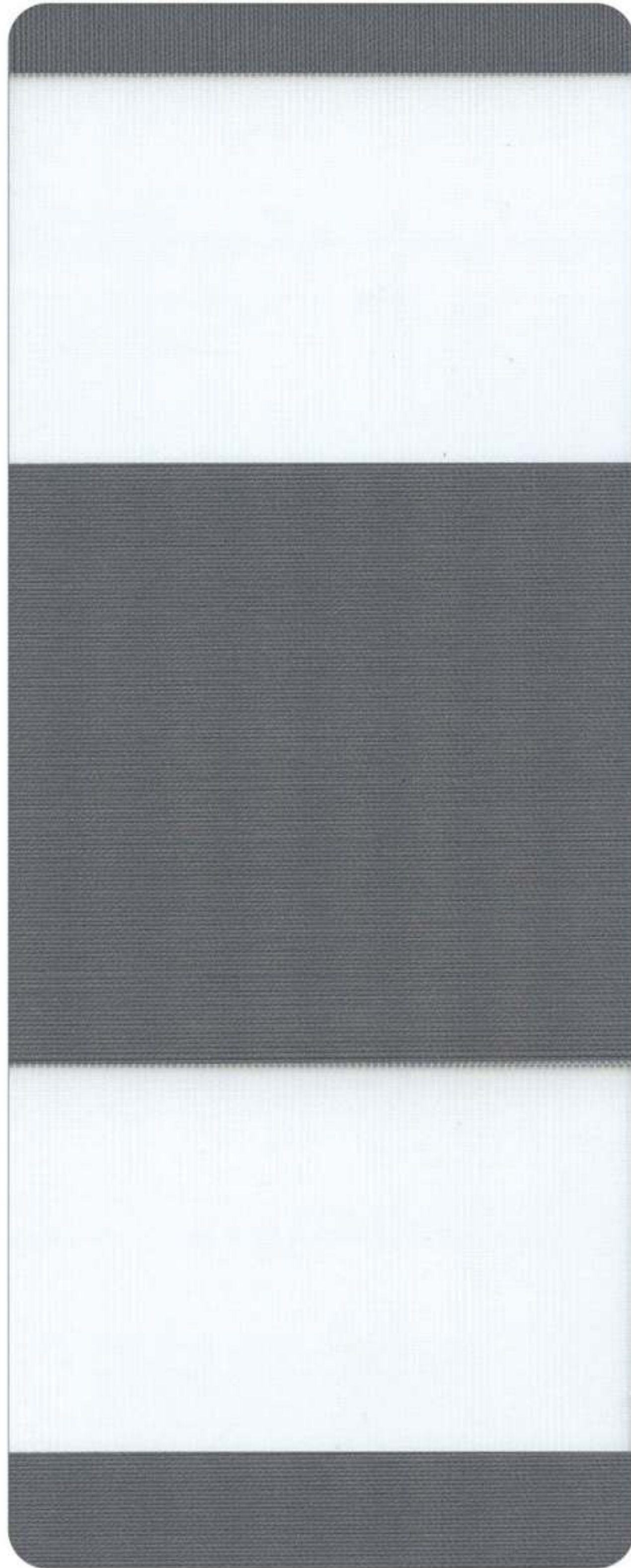

LE 4025 Charcoal 차콜

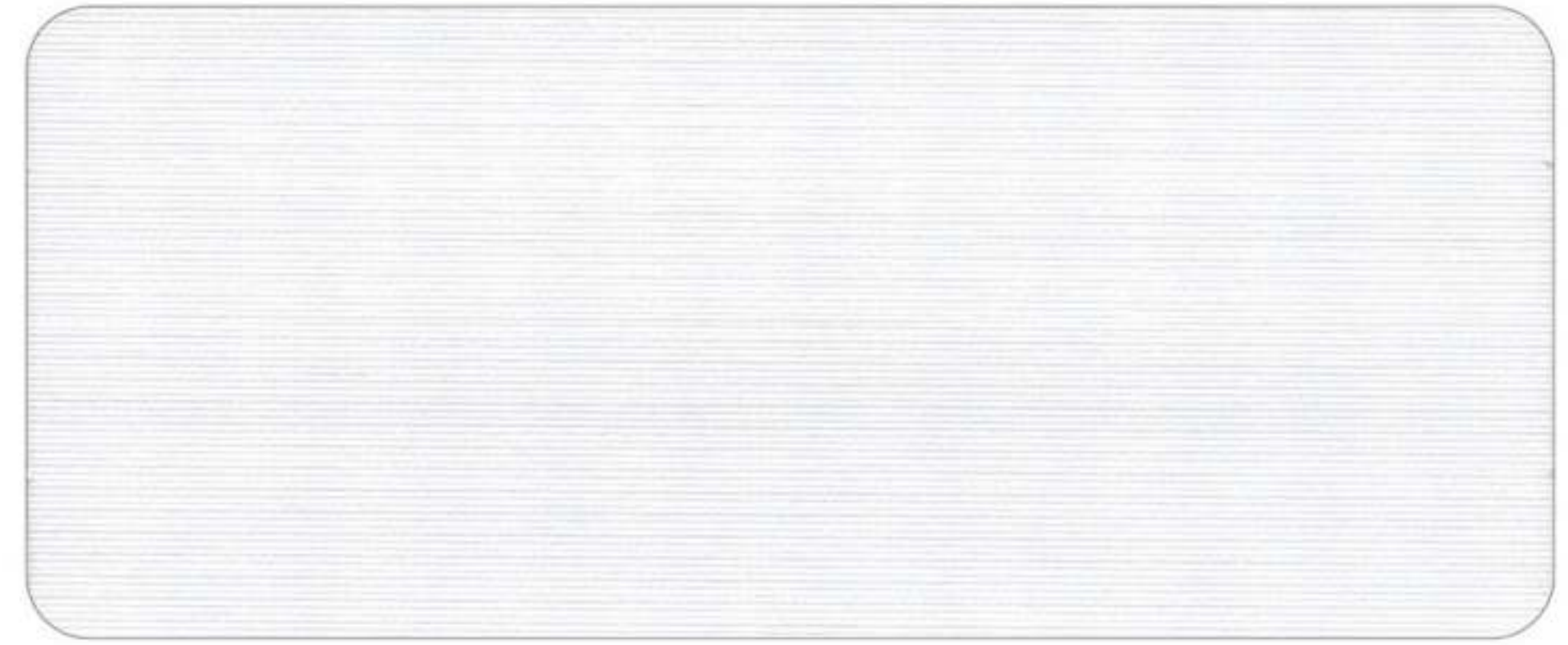

LE 4021 White 화이트



LE 4022 Cream 크림

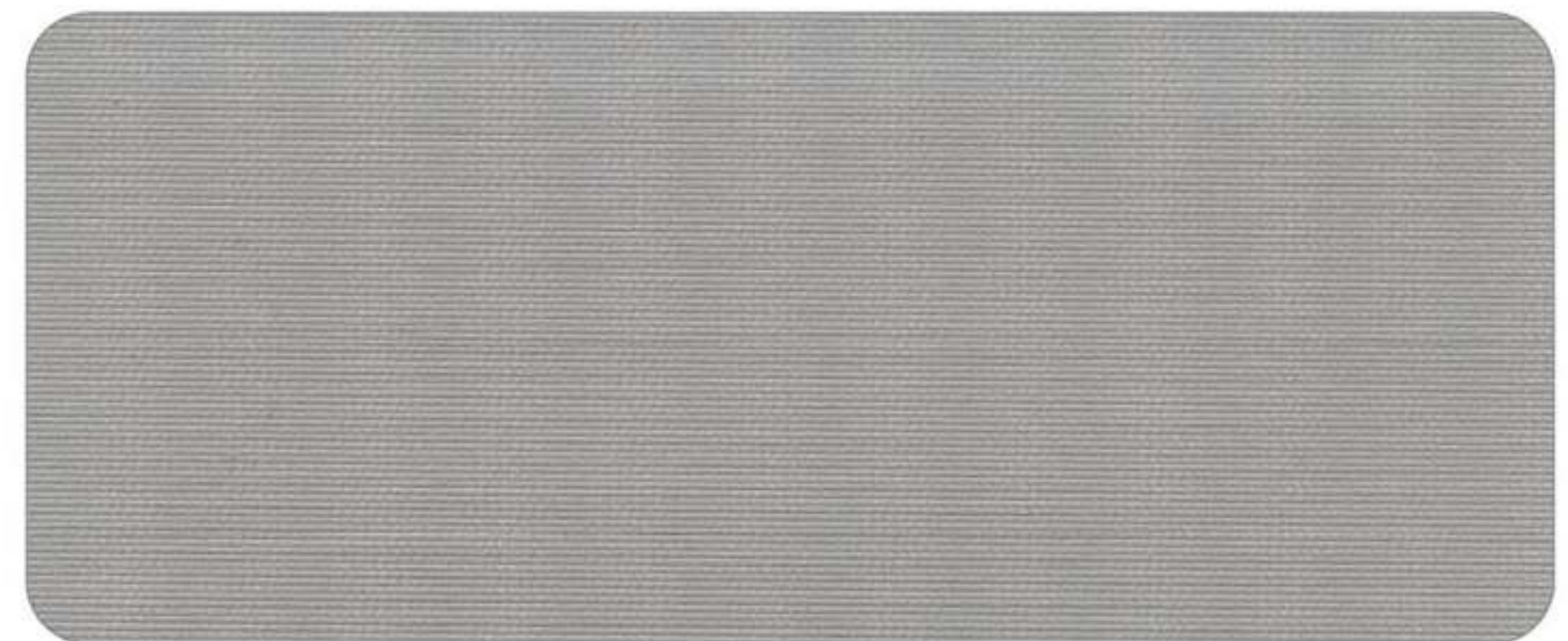

LE 4024 Grey 그레이

COMBI BLINDS | 루이스·Lewis

COMPOSITION	Polyester 100%	WIDTH	280cm
WEIGHT	144g / m ² ± 5 %	THICKNESS	0.35mm ± 5 %
REPEAT	Solid 75mm / Sheer 50mm	FIRE CLASSIFICATION	None



- 실내용 / 물세탁 금지 / 구겨짐 주의 / 터치블라인드 제작 가능.
- 생산 LOT에 따라 원단에 미세한 차이가 있을 수 있습니다.
- 앞장 상단의 QR코드를 스캔하시면 설치 이미지를 보실 수 있습니다.

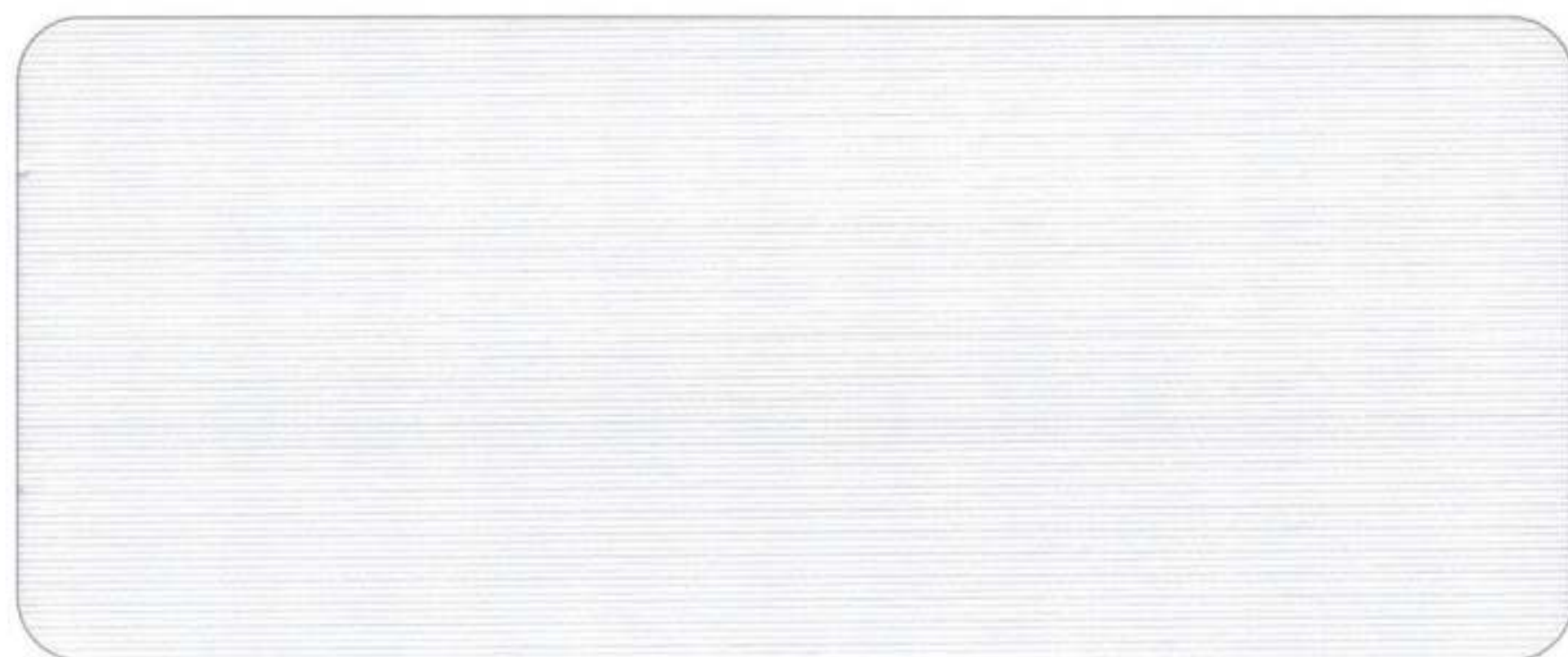

LE 4021 White 화이트



LE 4022 Cream 크림

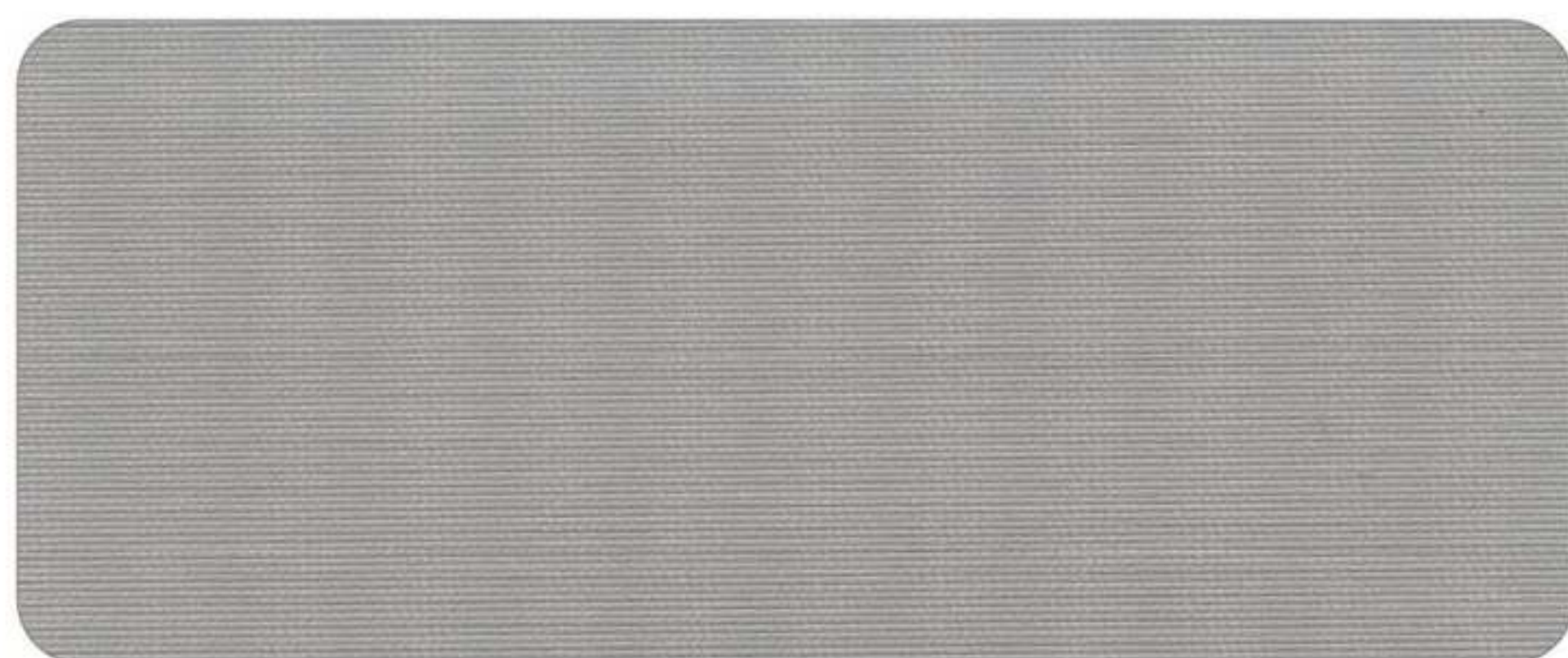

LE 4024 Grey 그레이

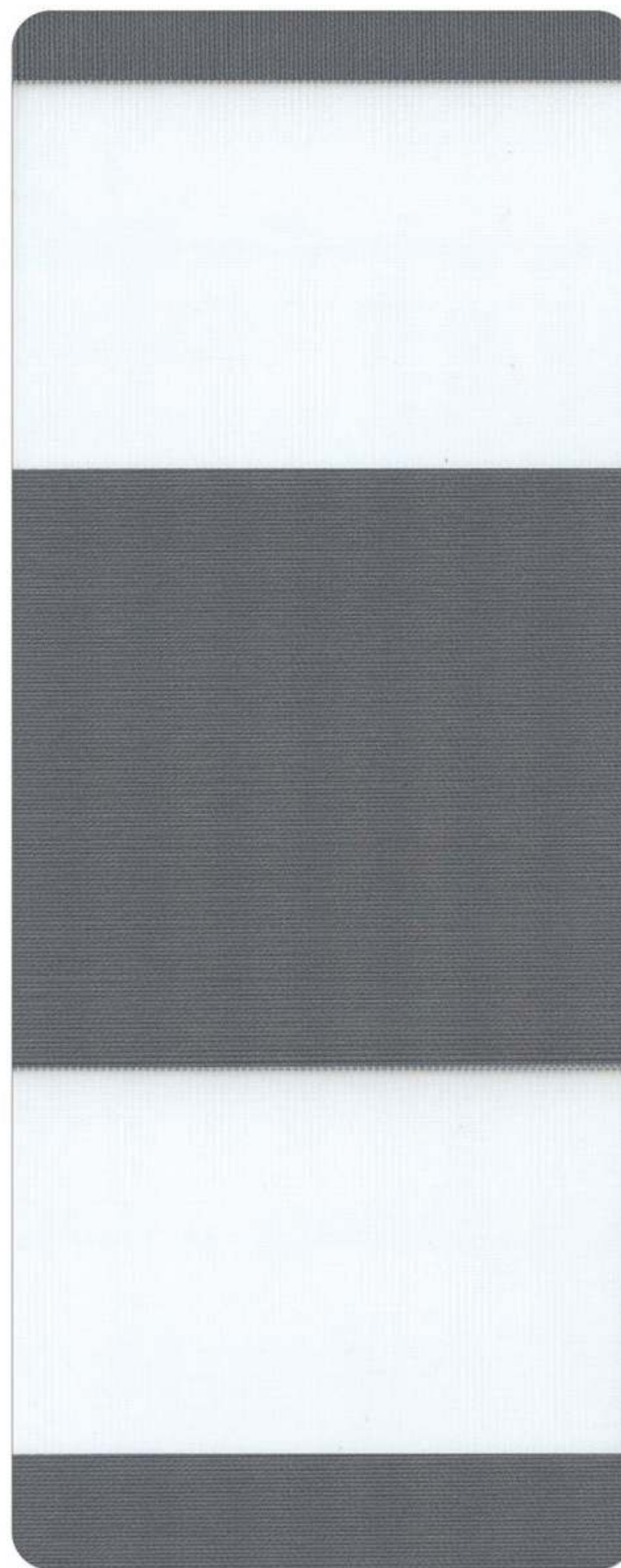

LE 4025 Charcoal 차콜



CODE NO. F160A50615

콤비 | 베일리

Bailey

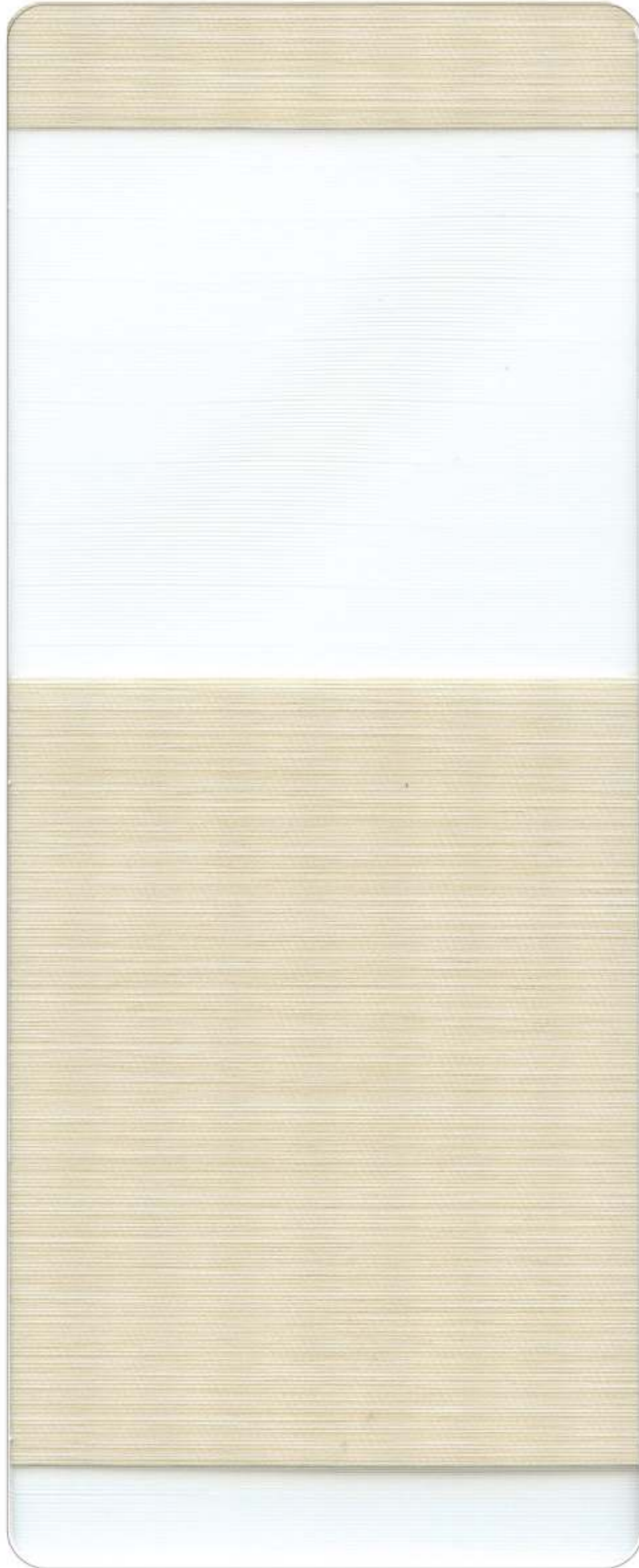

BA 5304 Beige 베이지

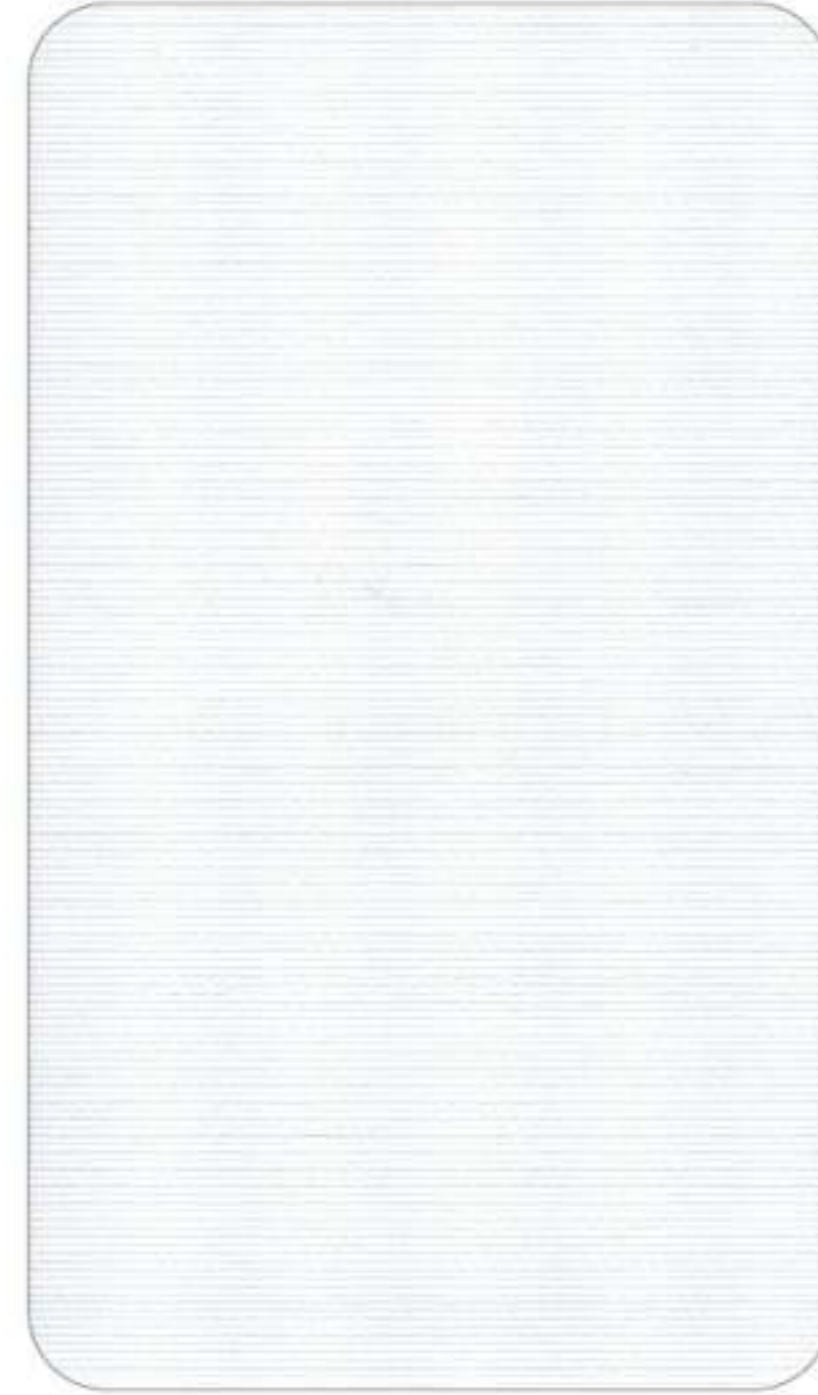

BA 5301 White 화이트



BA 5302 Ivory 아이보리



BA 5305 Silver Grey 실버 그레이



BA 5306 Shark Grey 샤크 그레이

COMBI BLINDS | 베일리·Bailey

COMPOSITION	Polyester 100%	WIDTH	280cm
WEIGHT	94g / m ² ± 5 %	THICKNESS	0.29mm ± 5 %
REPEAT	Solid 100mm / Sheer 70mm	FIRE CLASSIFICATION	None



- 실내용 / 물세탁 금지 / 구겨짐 주의 / 터치블라인드 제작 가능.
- 생산 LOT에 따라 원단에 미세한 차이가 있을 수 있습니다.
- 앞장 상단의 QR코드를 스캔하시면 설치 이미지를 보실 수 있습니다.

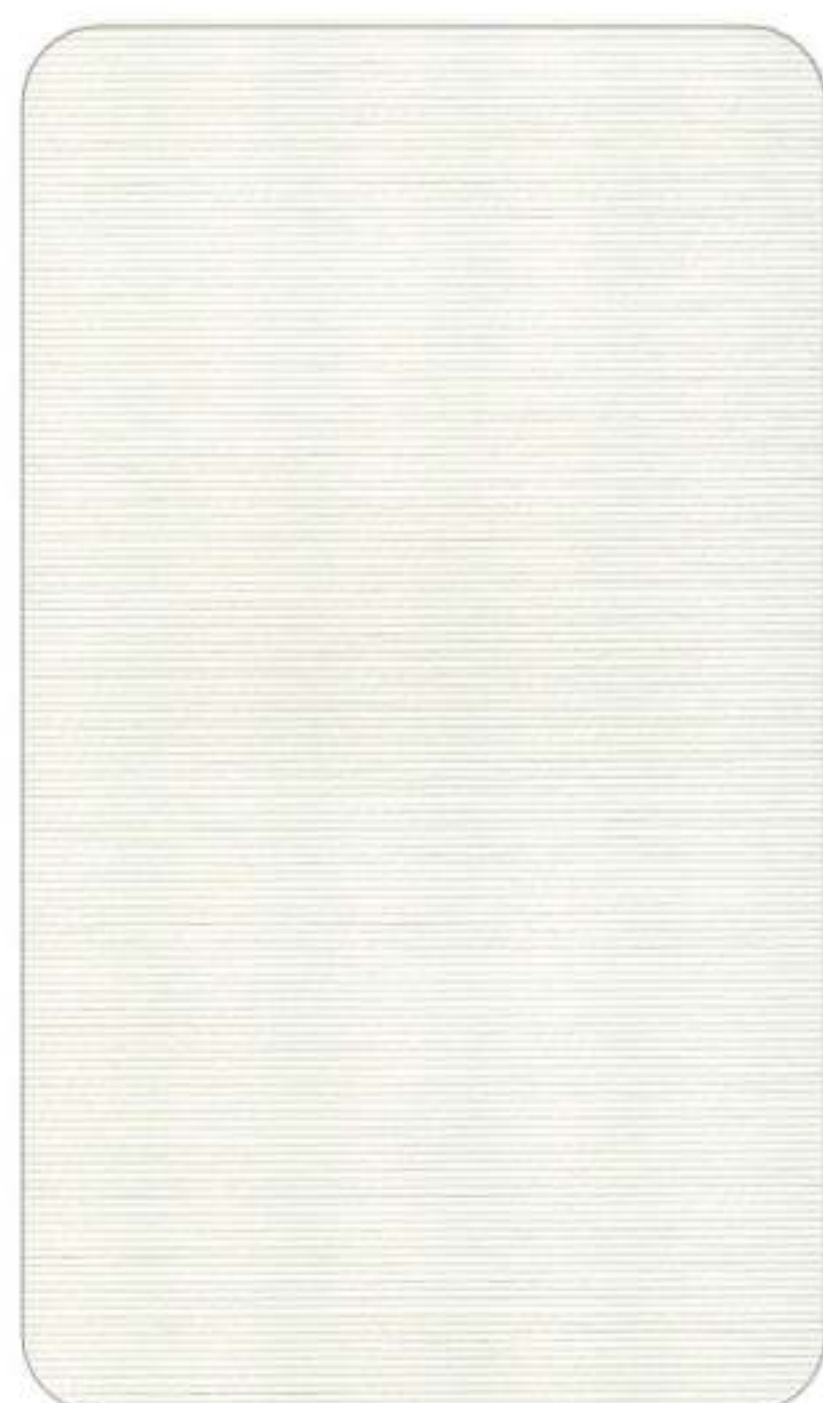

BA 5302 Ivory 아이보리

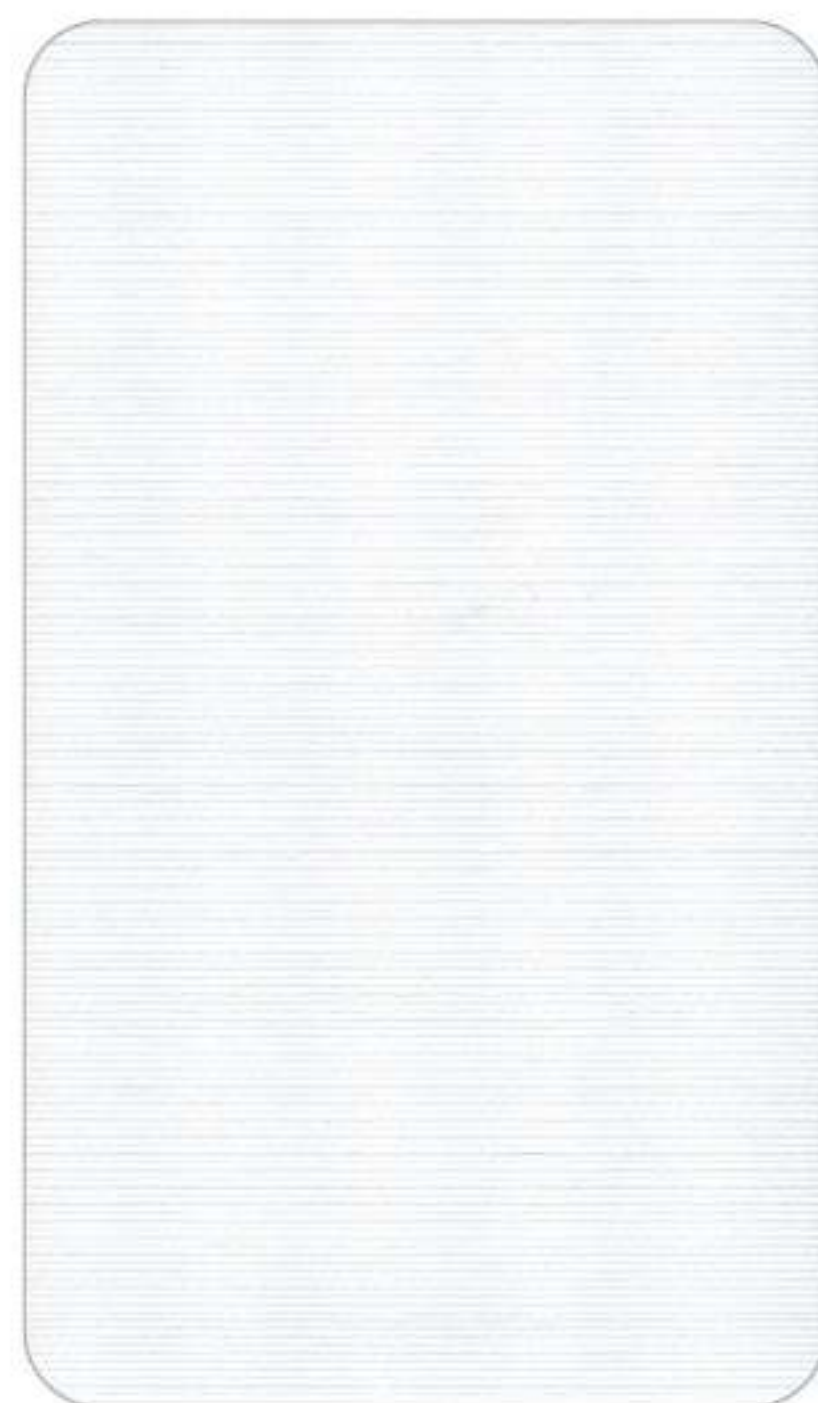

BA 5301 White 화이트



BA 5306 Shark Grey 샤크 그레이



BA 5305 Silver Grey 실버 그레이



BA 5304 Beige 베이지



CODE NO. G150A40413

콤비 | 아비스

Avis

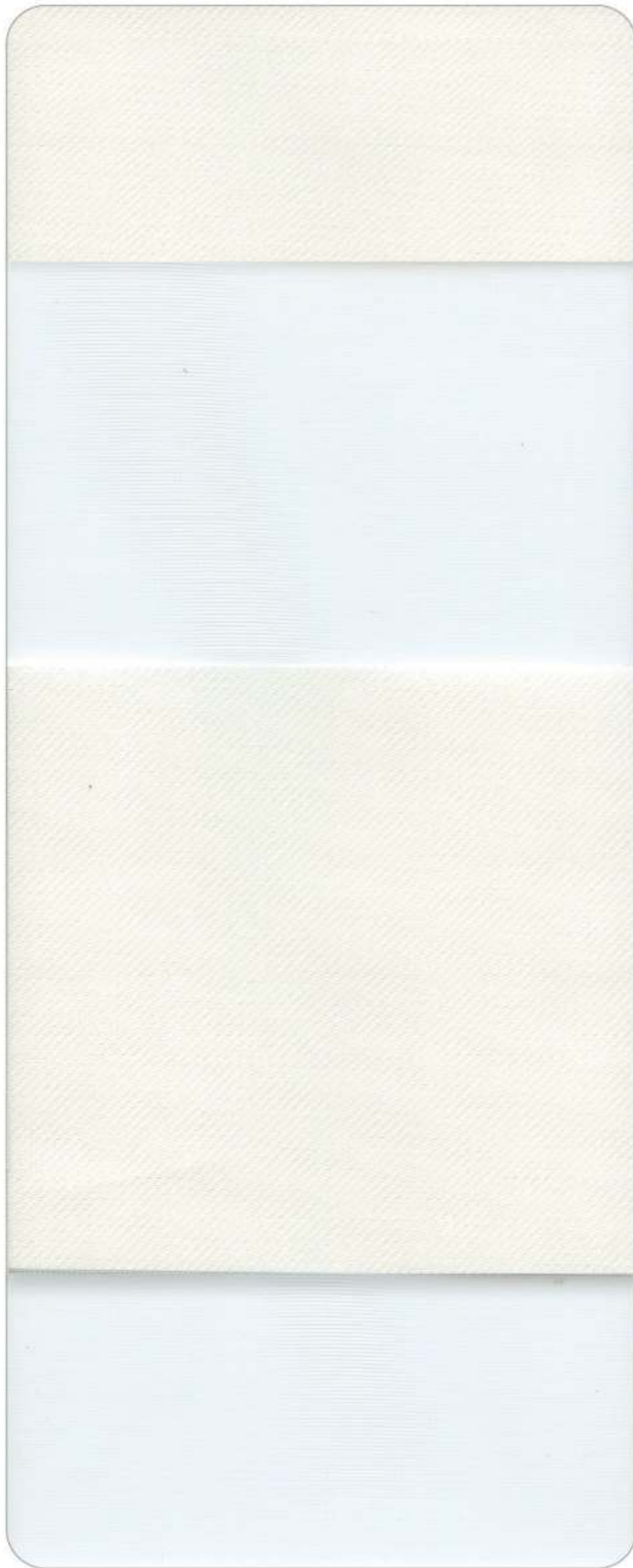

AV 1542 Ivory 아이보리

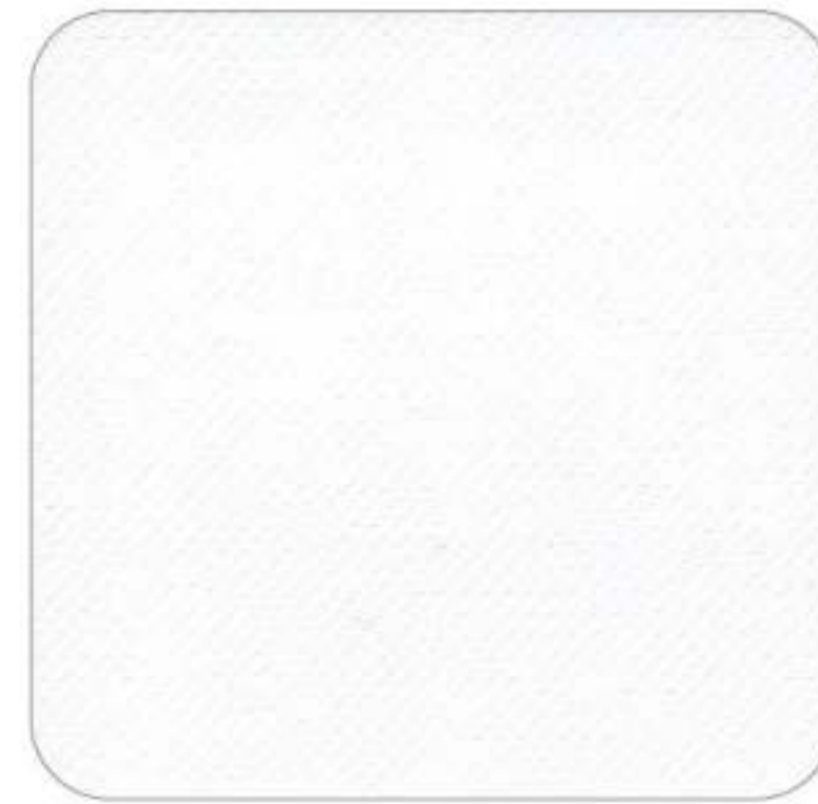

AV 1541 White 화이트

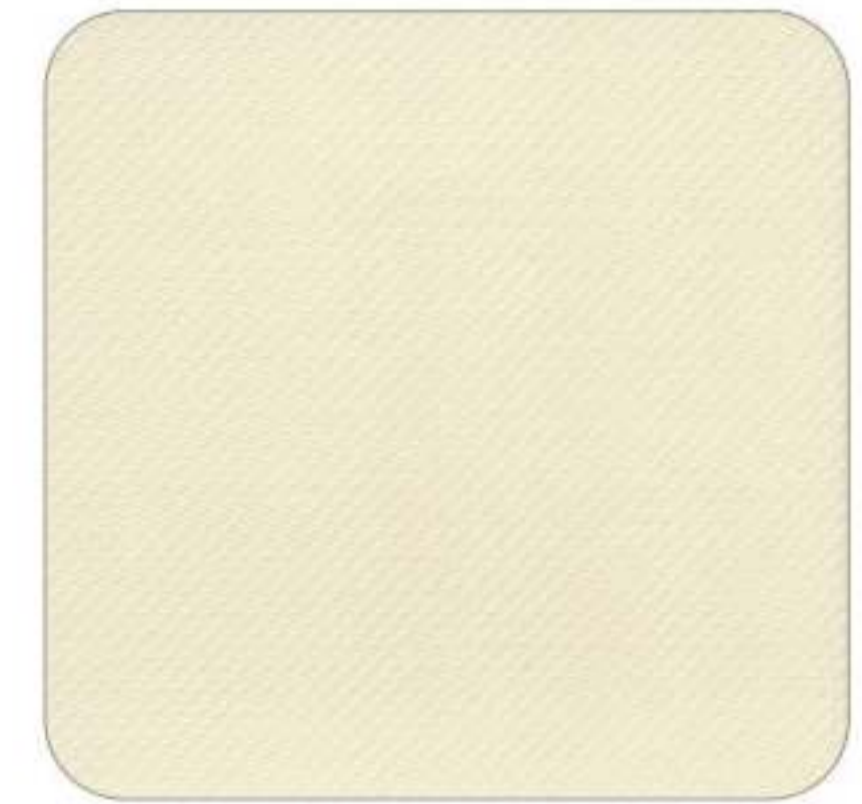

AV 1543 Beige 베이지

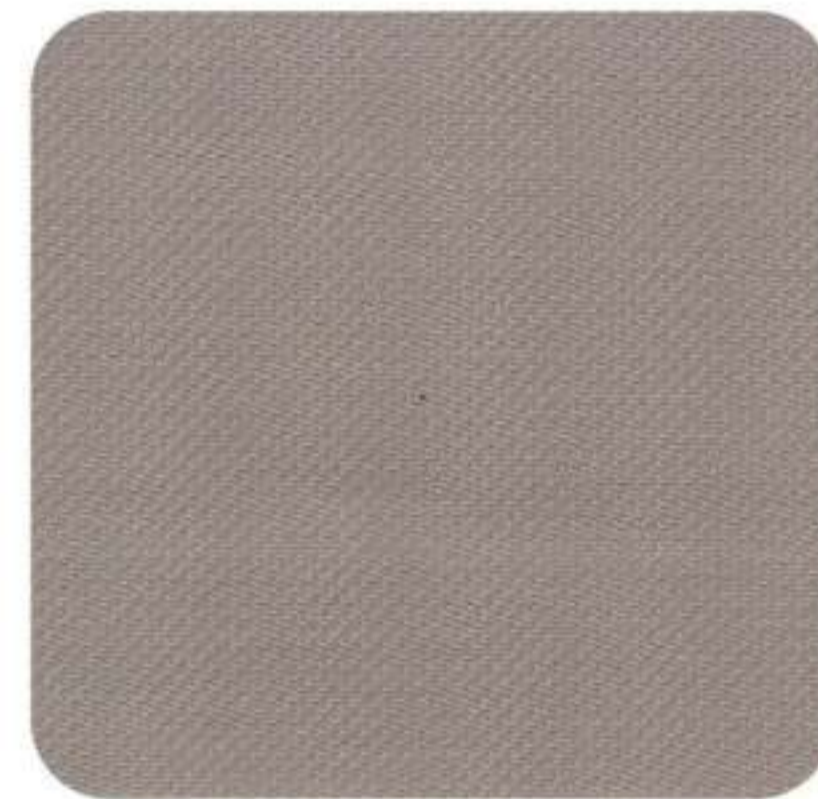

AV 1544 Khaki Brown 카키 브라운

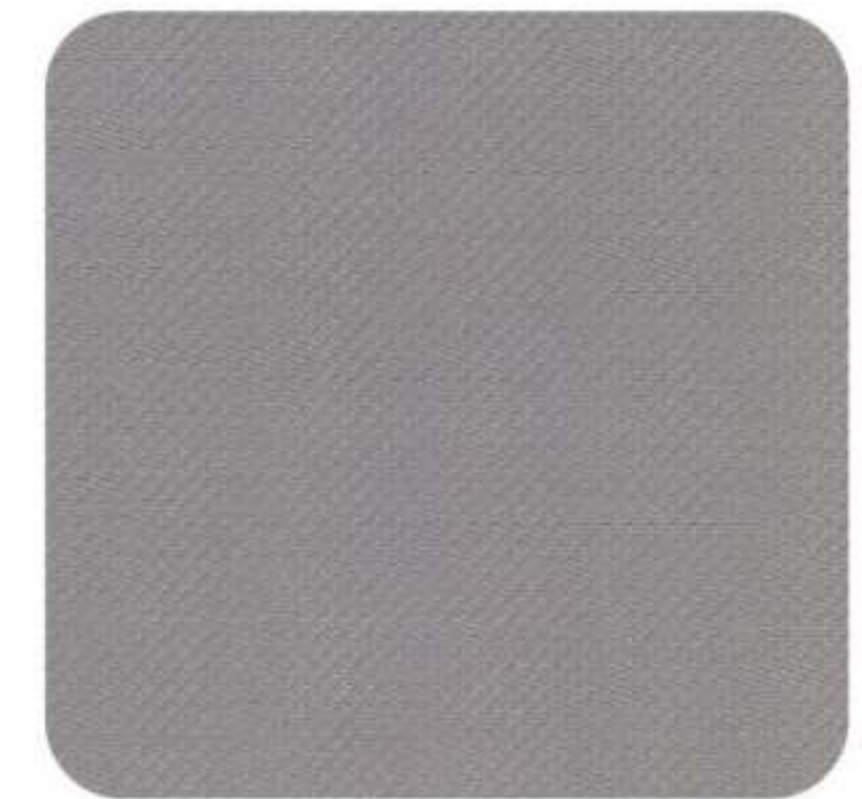

AV 1545 Shark Grey 샤크 그레이



AV 1546 Brich 브리치

COMBI BLINDS | 아비스·Avis

COMPOSITION	Polyester 100%	WIDTH	280cm
WEIGHT	99g / m ² ± 5 %	THICKNESS	0.26mm ± 5 %
REPEAT	Solid 75mm / Sheer 50mm	FIRE CLASSIFICATION	None



- 실내용 / 물세탁 금지 / 구겨짐 주의 / 터치블라인드 제작 가능.
- 생산 LOT에 따라 원단에 미세한 차이가 있을 수 있습니다.
- 앞장 상단의 QR코드를 스캔하시면 설치 이미지를 보실 수 있습니다.

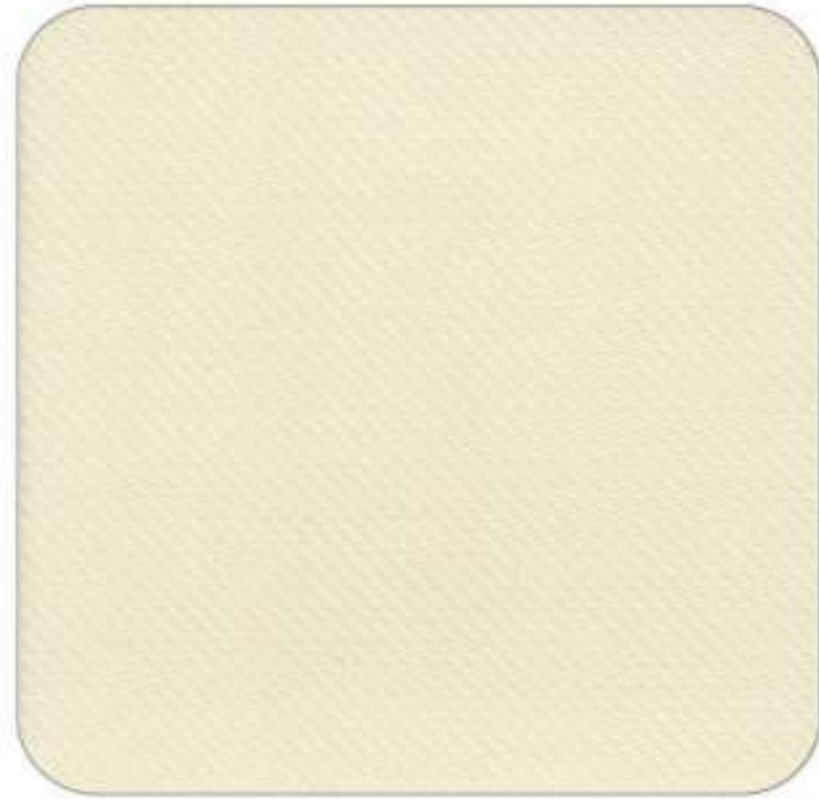

AV 1543 Beige 베이지

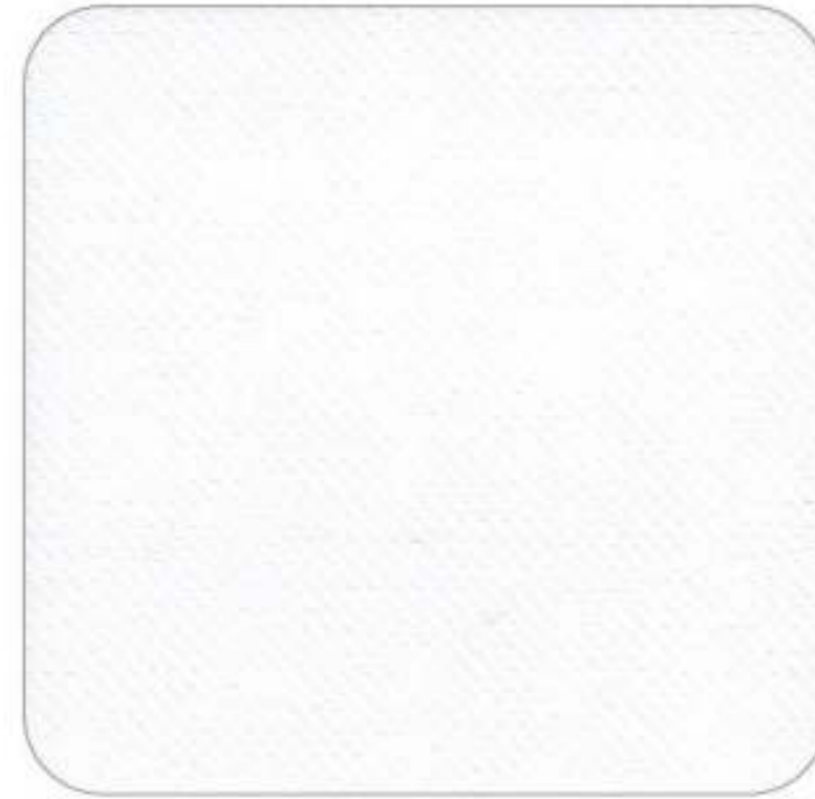

AV 1541 White 화이트



AV 1545 Shark Grey 샤크 그레이

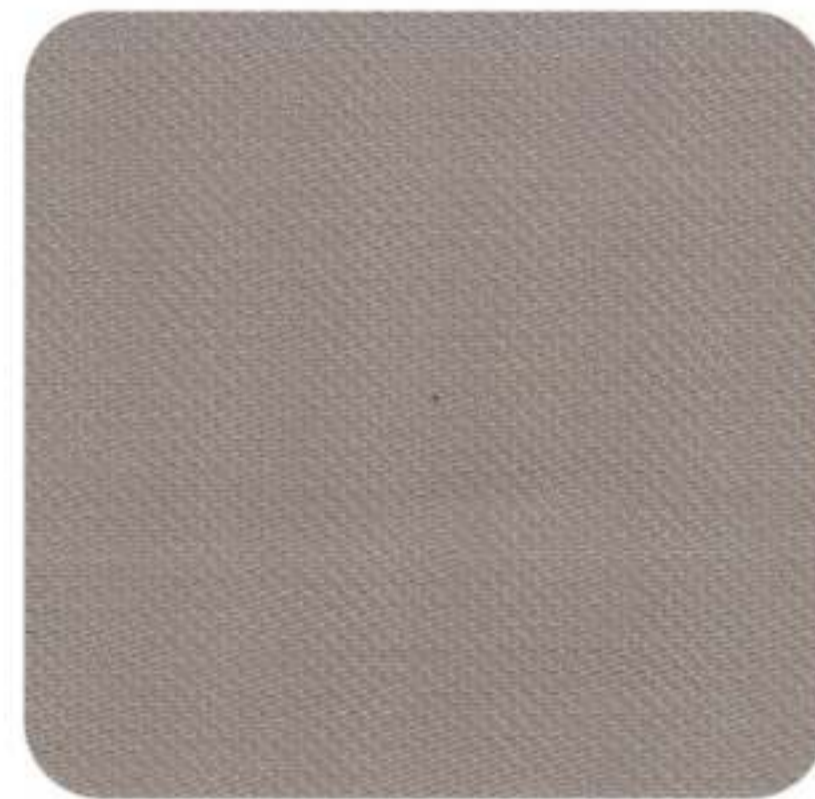

AV 1544 Khaki Brown 카키 브라운



AV 1546 Brich 브리치

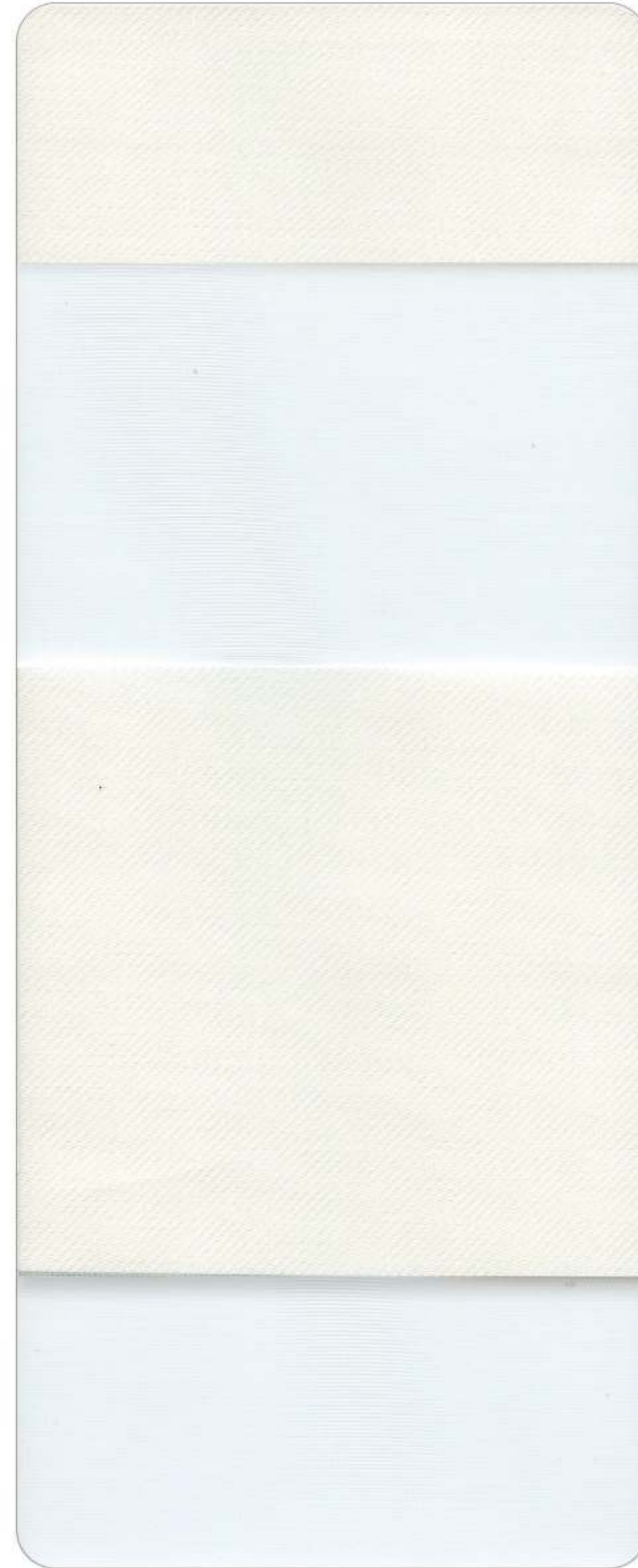

AV 1542 Ivory 아이보리



CODE NO. W140A30658

콤비 | 팀버룩 뷰

Timberlook View

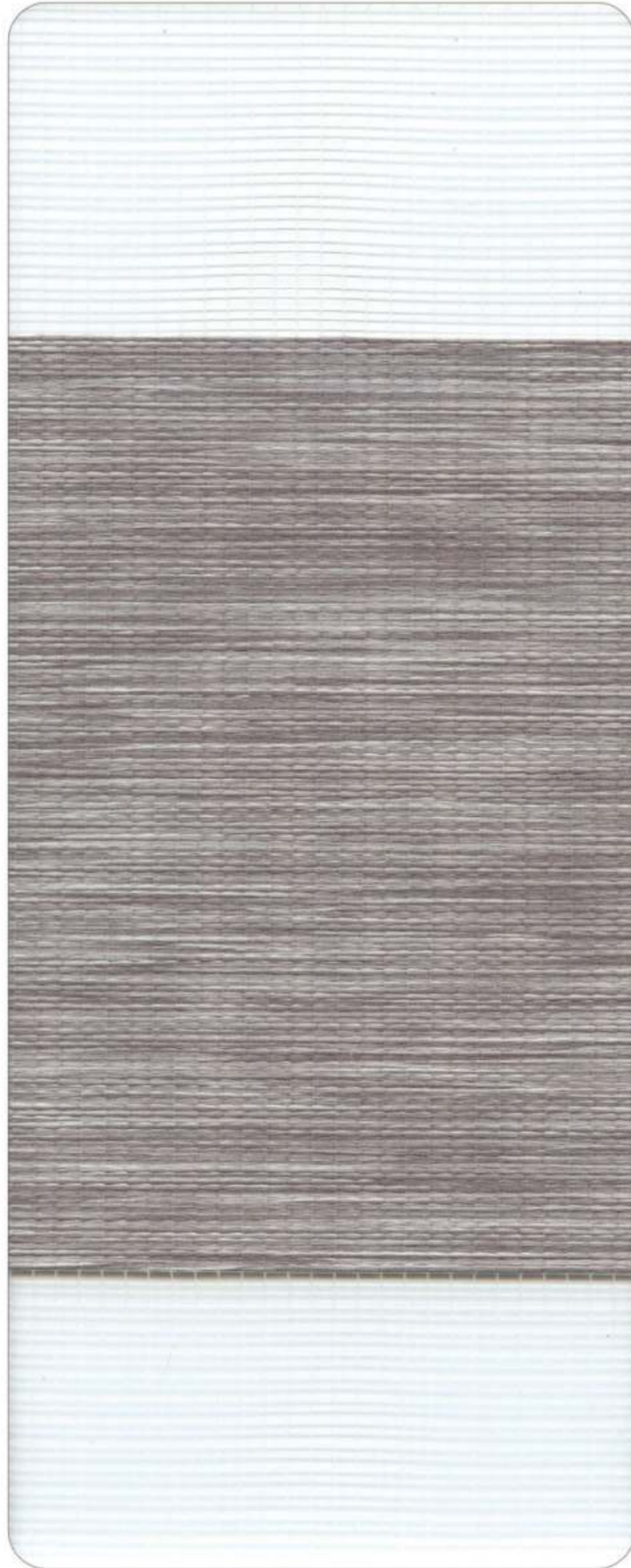

WLV 9238 Dim Grey 딤 그레이



WLV 9237 Light Ivory 라이트 아이보리



WLV 9231 White 화이트



WLV 9232 Ivory 아이보리



WLV 9235 Grey 그레이

COMBI BLINDS | 팀버룩 뷰·Timberlook View

COMPOSITION	Polyester 100%	WIDTH	280cm
WEIGHT	145g / m ² ± 5 %	THICKNESS	0.45mm ± 5 %
REPEAT	Solid 115mm / Sheer 90mm	FIRE CLASSIFICATION	None



- 실내용 / 물세탁 금지 / 구겨짐 주의 / 터치블라인드 제작 가능.
- 생산 LOT에 따라 원단에 미세한 차이가 있을 수 있습니다.
- 앞장 상단의 QR코드를 스캔하시면 설치 이미지를 보실 수 있습니다.



WLV 9231 White 화이트



WLV 9237 Light Ivory 라이트 아이보리



WLV 9235 Grey 그레이



WLV 9232 Ivory 아이보리

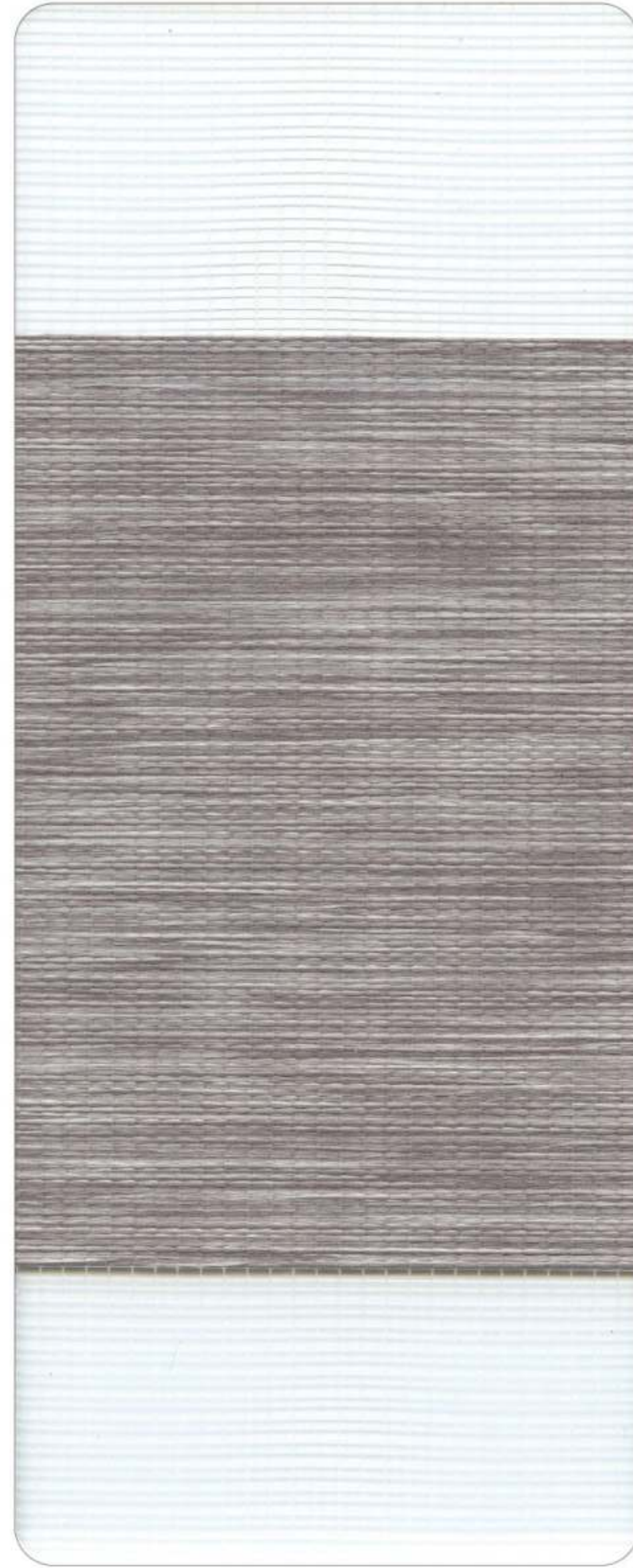

WLV 9238 Dim Grey 딤 그레이



CODE NO. R120A10795 (F/R: R150A40589)

콤비 | 팀버룩 (일부방염가능)

Timberlook

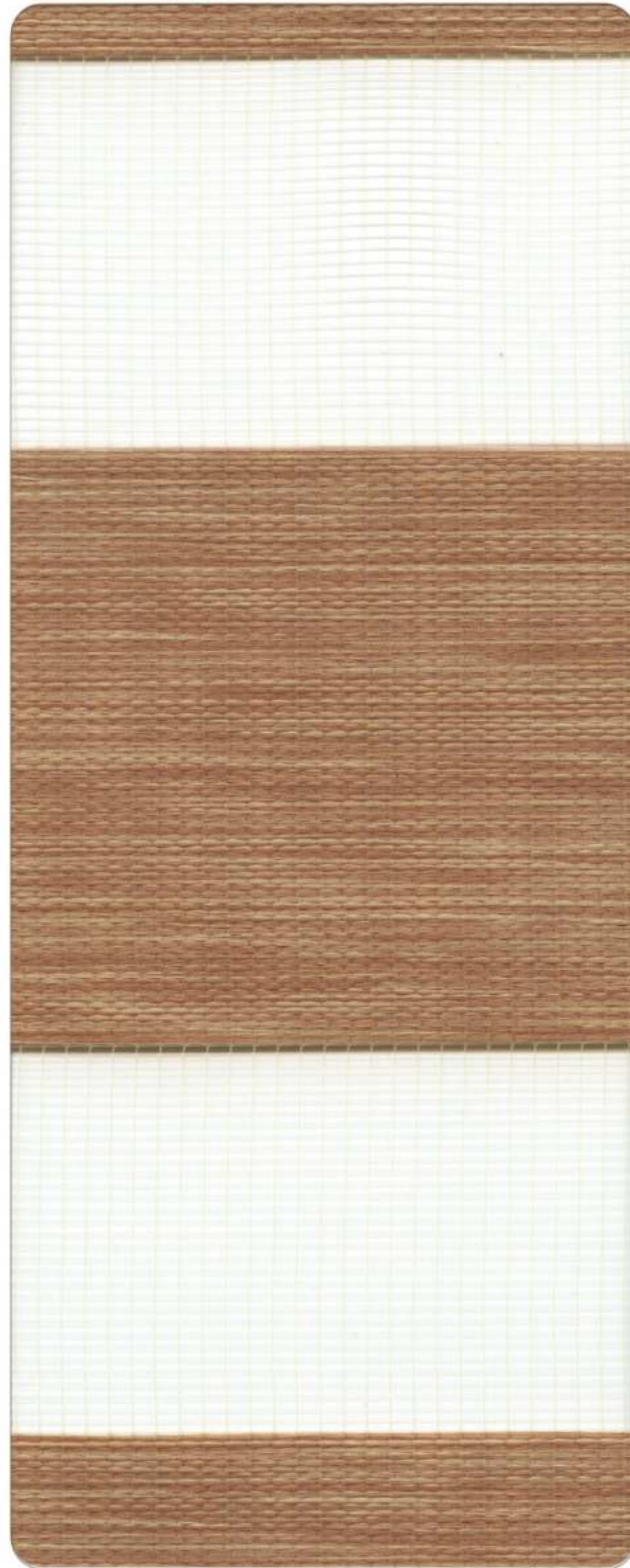

9222 Ice White 아이스 화이트



9201 (비방염) White 화이트
TF 9271 (방염)



9223 Light Ivory
라이트 아이보리



9202 (비방염) Ivory 아이보리
TF 9272 (방염)



9213 (비방염) Peach 피치
TF 9283 (방염)



9210 Sand 샌드

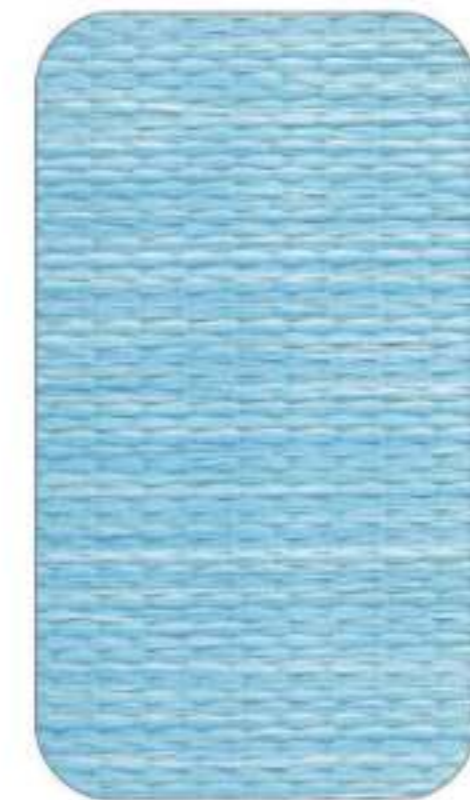

9216 Blue 블루



9207 (비방염) Glass 글래스
TF 9277 (방염)



9208 Green 그린



9211 Chocolate 초콜렛



9204 (비방염) Brown 브라운
TF 9274 (방염)



9205 Khaki 카키



9214 Pink 핑크



9224 Ash Grey 애쉬 그레이



9209 (비방염) Grey 그레이
TF 9279 (방염)



9227 Dim Grey 딤 그레이



9219 Dark Grey 다크 그레이



9212 Charcoal 차콜

9203 (비방염) Cherry 체리
TF 9273 (방염)

콤비 | 팀버룩 (일부방염가능)

Timberlook



COMBI BLINDS | 팀버룩 (일부방염가능) · Timberlook (F/R Available Partly)

COMPOSITION	Polyester 100%	WIDTH	280cm
WEIGHT	135g / m ² ± 5 %	THICKNESS	0.45mm ± 5 %
REPEAT	Solid 75mm / Sheer 50mm	FIRE CLASSIFICATION	None or F/R



·실내용 / 물세탁 금지 / 구겨짐 주의 / 터치블라인드 제작 가능.
 ·생산 LOT에 따라 원단에 미세한 차이가 있을 수 있습니다.
 ·앞장 상단의 QR코드를 스캔하시면 설치 이미지를 보실 수 있습니다.



9210 Sand 샌드



9213 (비방염) Peach 피치
TF 9283 (방염)



9202 (비방염) Ivory 아이보리
TF 9272 (방염)



9223 Light Ivory
라이트 아이보리



9201 (비방염) White 화이트
TF 9271 (방염)



9222 Ice White 아이스 화이트



9205 Khaki 카키



9204 (비방염) Brown 브라운
TF 9274 (방염)



9211 Chocolate 초콜렛



9208 Green 그린



9207 (비방염) Glass 글래스
TF 9277 (방염)



9216 Blue 블루



9212 Charcoal 차콜



9219 Dark Grey 다크 그레이



9227 Dim Grey 딴 그레이



9209 (비방염) Grey 그레이
TF 9279 (방염)



9224 Ash Grey 애쉬 그레이



9214 Pink 핑크



9203 (비방염) Cherry 체리
TF 9273 (방염)

CODE NO. H100090152 (F/R: H130A20689)

콤비 | 모닝 (일부방염가능)

Morning

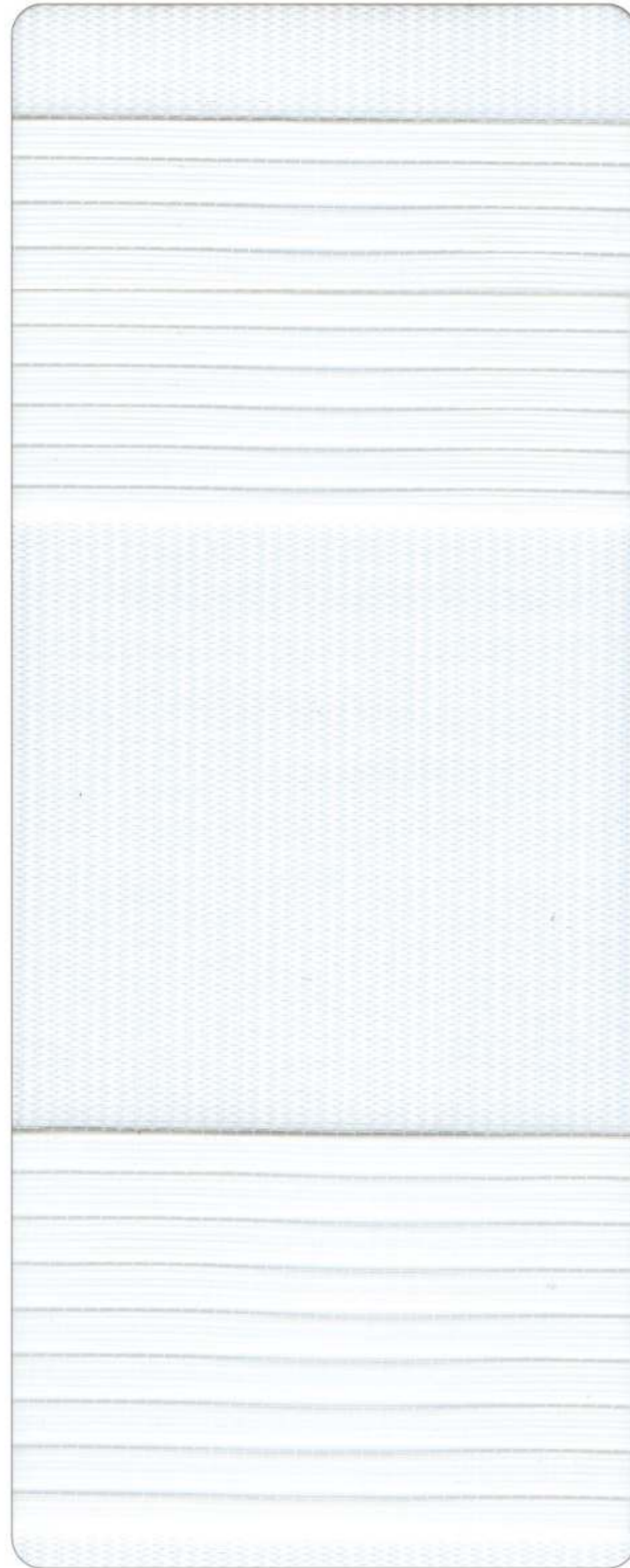

6324 Ice White 아이스 화이트



6301 (비방염) White 화이트
MF 6471 (방염)



6302 (비방염) Ivory 아이보리
MF 6472 (방염)



6310 Oyster 오이스터



6303 Peach 피치



6304 Brown 브라운



6311 Caramel 카라멜



6305 Pink 핑크



6322 Yellow Green
옐로우 그린



6307 Yellow 옐로우



6326 Mushroom 머쉬룸



6321 Tarp 타프



6312 Chocolate 초콜렛



6320 D.Blue 진블루



6306 (비방염) Blue 블루
MF 6476 (방염)



6318 (비방염) Grey 그레이
MF 6488 (방염)



6327 (비방염) Dim Grey 딤 그레이
MF 6497 (방염)



6328 Dark Grey 다크 그레이



6313 Black & White
블랙 앤 화이트

콤비 | 모닝 (일부방염가능)
Morning



COMBI BLINDS | 모닝 (일부방염가능) · Morning (F/R Available Partly)

COMPOSITION	Polyester 100%	WIDTH	280cm
WEIGHT	98g / m ² ± 5 %	THICKNESS	0.25mm ± 5 %
REPEAT	Solid 75mm / Sheer 50mm	FIRE CLASSIFICATION	None or F/R



·실내용 / 물세탁 금지 / 구겨짐 주의 / 터치블라인드 제작 가능.
·생산 LOT에 따라 원단에 미세한 차이가 있을 수 있습니다.
·앞장 상단의 QR코드를 스캔하시면 설치 이미지를 보실 수 있습니다.



6311 Caramel 카라멜



6304 Brown 브라운



6303 Peach 피치



6310 Oyster 오이스터



6302 (비방염) Ivory 아이보리
MF 6472 (방염)



6301 (비방염) White 화이트
MF 6471 (방염)



6312 Chocolate 초콜렛



6321 Tarp 타프



6326 Mushroom 머쉬룸



6307 Yellow 옐로우



6322 Yellow Green
옐로우 그린



6305 Pink 핑크



6313 Black & White
블랙 앤 화이트



6328 Dark Grey 다크 그레이



6327 (비방염) Dim Grey 딴 그레이
MF 6497 (방염)



6318 (비방염) Grey 그레이
MF 6488 (방염)



6306 (비방염) Blue 블루
MF 6476 (방염)



6320 D.Blue 진블루

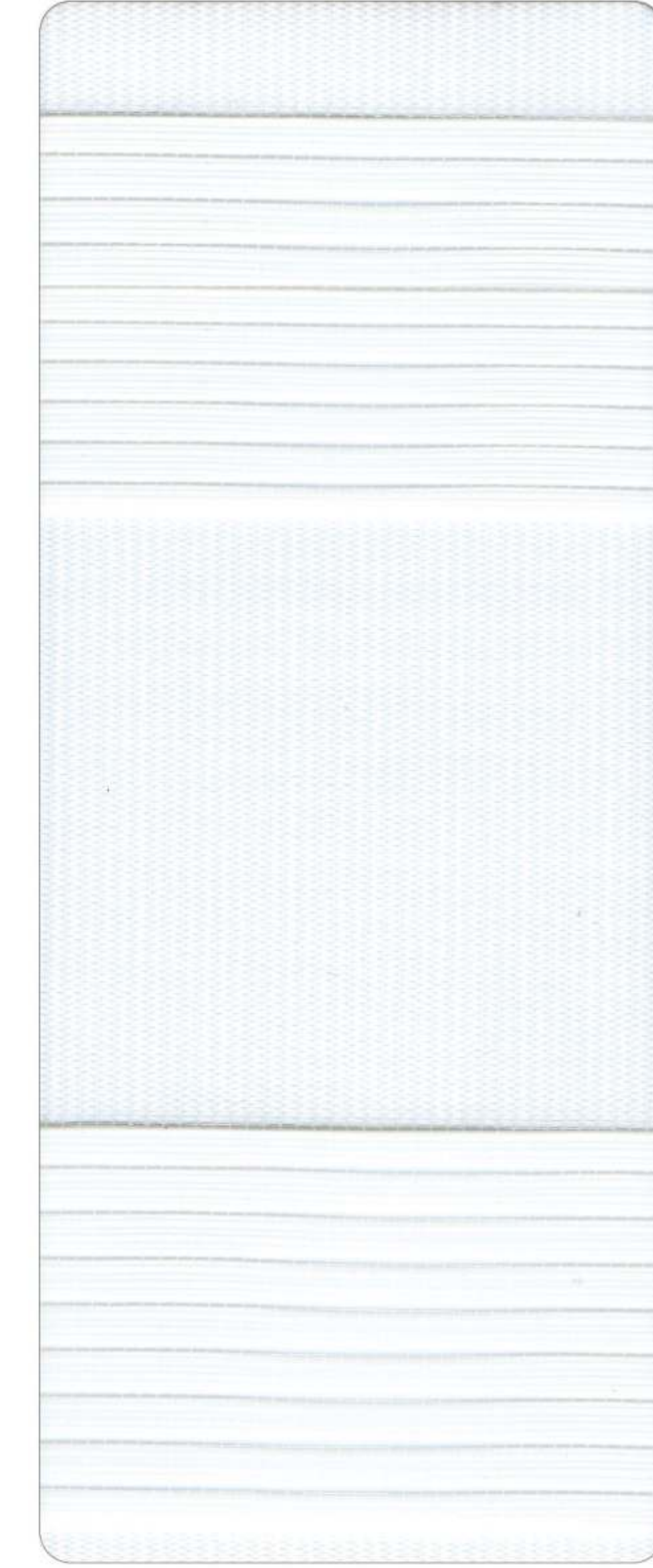

6324 Ice White 아이스 화이트